

Progr. Universal-Transmitter PMT 50

Signal conditioning - linearization - output characteristic transformation

Features

- Input for standard signals, resistance/poti or Pt100/Pt1000 and thermocouples J, K, N, S
- Measuring range programmable
- Installed units:
mV, V, mA, A, Ω , k Ω , μ S/cm, mS/cm, °C, °F, min⁻¹, rpm, bar, mbar, hPa, mm, cm, m, %, °, l, l/min, m³, m³/h, ppm and custom units programmable
- Transmitter supply 24 V DC max. 30 mA
- Linearization or transformation of output characteristic via 32 base-points programmable
- Basic accuracy <0.2 %
- Teach-In and simulator function
- Fault monitoring for break of wire and short-circuit in the measuring circuit
- Programmable fault function
Analog output min. or max. overflow
Alarm outputs min. or max. function
- Analog output 0/4 ... 20 mA; 0/2 ... 10 V DC
- 4 alarm outputs (relay SPDT)
- Fieldbus connection MODBUS RTU/ASCII RS485/Profibus DP
- Full 3-port isolation



General

The programmable universal transmitter PMT50 operates with analog input signals. The device convert input signals to analog output 0/4 ... 20 mA; 0/2 ... 10 V DC. Optional a serial interface is available. The device offers a linearization function for any sensor curves and a simulator function. The integrated transmitter supply 24 V DC max. 30 mA allows the feeding of 2-and 3-wire sensors. 4 alarm outputs for monitoring and controlling are available.

Short information

Programming	The device is programmed via frontal buttons, in association with the LCD display.
Alarm outputs	The alarm outputs can be programmed as max. or min. function. Switch-on delay and switch-off delay time is programmable from 1 s up to 9 h. The switching status is displayed through LED's.
Teach-In function	The input signals for start- and end value or the values of the characteristic curve will be stored automatically. Only the corresponding display values have to be entered manually.
Fault function	A fault in the measuring circuit could be monitored (break of wire/short-circuit). The switching function of the analog and alarm output(s) is programmable in case of an fault.

Technical data

Power supply

Supply voltage : 230 V AC $\pm 10\%$, 115 V AC $\pm 10\%$, or 24 V DC $\pm 15\%$
 Power consumption : max. 5 VA
 Operating temperature : -10 ... 55 °C (14 ... 131 °F)
 Rated voltage : 250 VAC acc. to DIN EN 60664-1

between input/relay output/analog output/supply voltage
 degree of pollution 2, overvoltage category III

Test voltage : 4 kV DC between input/relay output/analog output/supply voltage

CE-conformity

Standardize IEC61326 05/2004			Result
IEC 61000-4-2 (ESD)	Case	4 kV/8 kV contact/air 10 V/m 30 A/m	B
IEC 61000-4-3 (E-field)			A
IEC 61000-4-8 (Magnetic field)			dispensed with
IEC 61000-4-11 (Voltage dip)	AC power supply connection	0.5 period, $\pm 100\%$ 2 kV 1 kV L/N, 2 kV L,N/PE 3 V	A
IEC 61000-4-4 (Burst)			A
IEC 61000-4-5 (Surge)			A
IEC 61000-4-6 (HF- current feed)			A
IEC 61000-4-4 (Burst)	DC power supply connection	2 kV 1 kV L/N, 2 kV L,N/PE 3 V	A
IEC 61000-4-5 (Surge)			A
IEC 61000-4-6 (HF- current feed)			A
IEC 61000-4-4 (Burst)	Input/output, signal/control	1 kV 1 kV L/N/PE 3 V	A
IEC 61000-4-5 (Surge)			B
IEC 61000-4-6 (HF- current feed)			A
CISPR16-1/16-2	Radiated interference		Passed

Inputs

Fault detection : Model 1 + 2 (only resistance) break of wire;
 Model 3 break of wire (RTD,Thermo couple) and short-circuit (only RTD)

Model 1

Input : 0/2 ... 10 V, 0/4 ... 20 mA
 Basic accuracy : $< 0.1\%$, ± 1 Digit
 Temperature coefficient : 0.01 %/K
 Transmitter supply : 24 V DC max. 30 mA

Model 2

Input : Resistance 0 ... 100 k Ω , potentiometer 1 ... 100 k Ω
 Basic accuracy : $< 0.2\%$, ± 1 Digit
 Temperature coefficient : 0.01 %/K

Model 3

Input : Pt100 (3-wire) -100.0 ... 600.0 °C / -100 ... 600 °C
 Pt1000 (3-wire) -100.0 ... 300.0 °C / -100 ... 300 °C
 : Thermo couple
 Type J -100.0 ... 800.0 °C / -100 ... 800 °C
 Type K -150 ... 1200 °C
 Type N -150 ... 1200 °C
 Type S -50 ... 1600 °C

Basic accuracy : $< 0.1\%$, ± 1 Digit

Temperature coefficient : 0.01 %/K

Outputs

Alarm outputs A1-A4 : Relay SPDT < 250 V AC < 250 VA < 2 A $\cos\phi \geq 0.3$, < 300 V DC < 40 W < 2 A
 Analog output : 0/4 ... 20 mA burden $\leq 500 \Omega$; 0/2 ... 10 V burden $> 500 \Omega$, galv. isolated, output changes automatically (burden impedance dependent)

Fieldbus

Modbus : RS485, RTU or ASCII max. 38400 Baud
 Profibus : Profibus DP
 Connection : 9pol. D-SUB connector socket in the front

Fault function

: For break of wire or short-circuit detection -belongs to the model-
 → Analog output 0 mA, < 3.6 mA or > 21.5 mA programmable
 → Alarm output(s) min. or max. function programmable

Display

: Graphic LCD-Display 128x64 pixels, white background illuminated

Case

: Polyamide (PA) 6.6, UL94V-0, DIN rail mounting TS 35

Weight

: Approx. 450 g

Connection

: Screw terminals 0.14 ... 2.5 mm² (AWG 26 .. 14)

Protection

: Case IP30, terminals IP20, German BGV A3

Connection diagrams

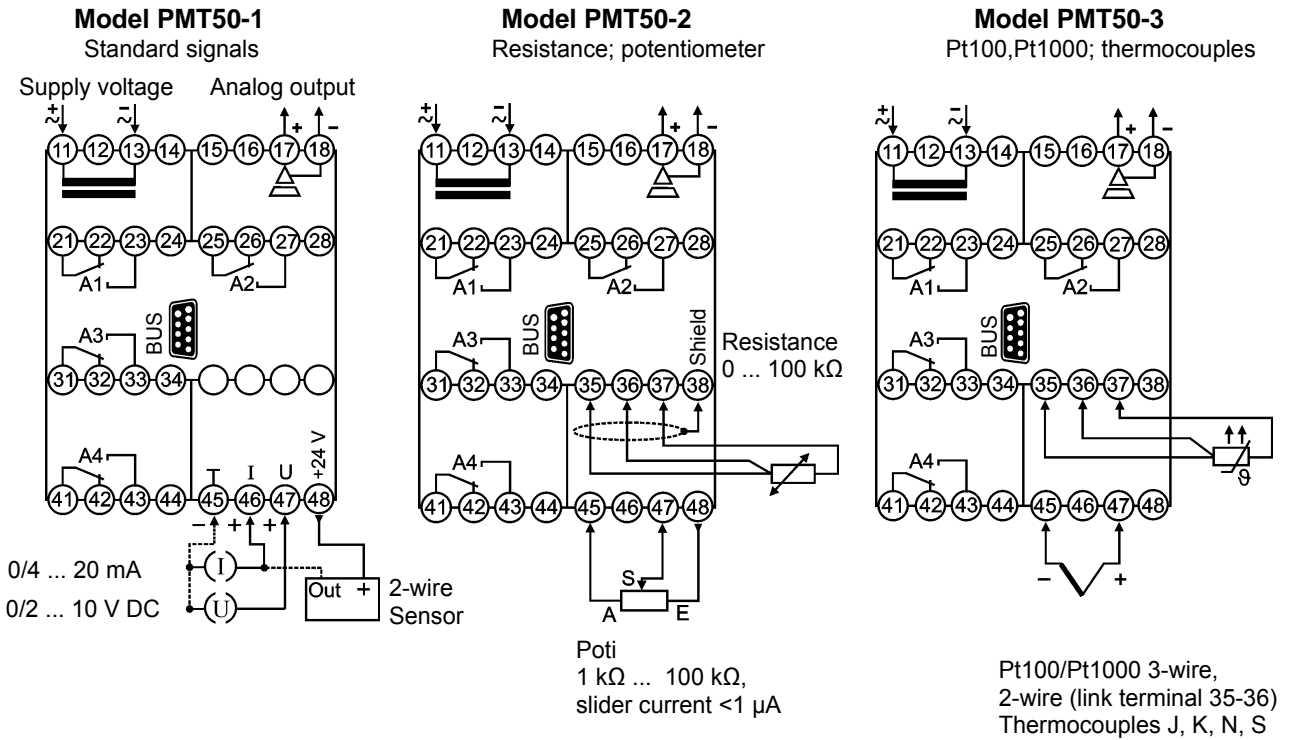

Dimensions

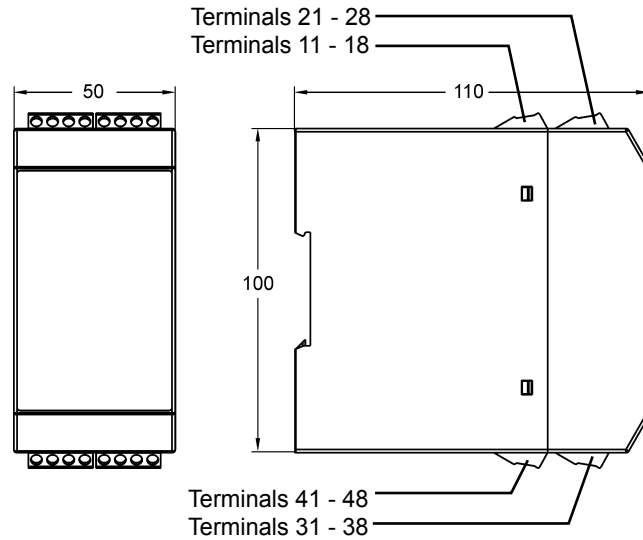

Bus connection (serial interface)

Modbus		
PIN	Signal	EIA/TIA-485 Name
5	TXD1	B
9	TXD0	A
1	Common	C/C'
Profibus		
3	RxD/TxD-P	
5	DGND	
6	VP/+5V max 10 mA	
8	RxD/TxD-N	

9pol. D-Sub connector in the front

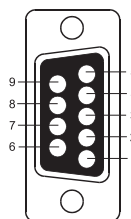

Control and indicators

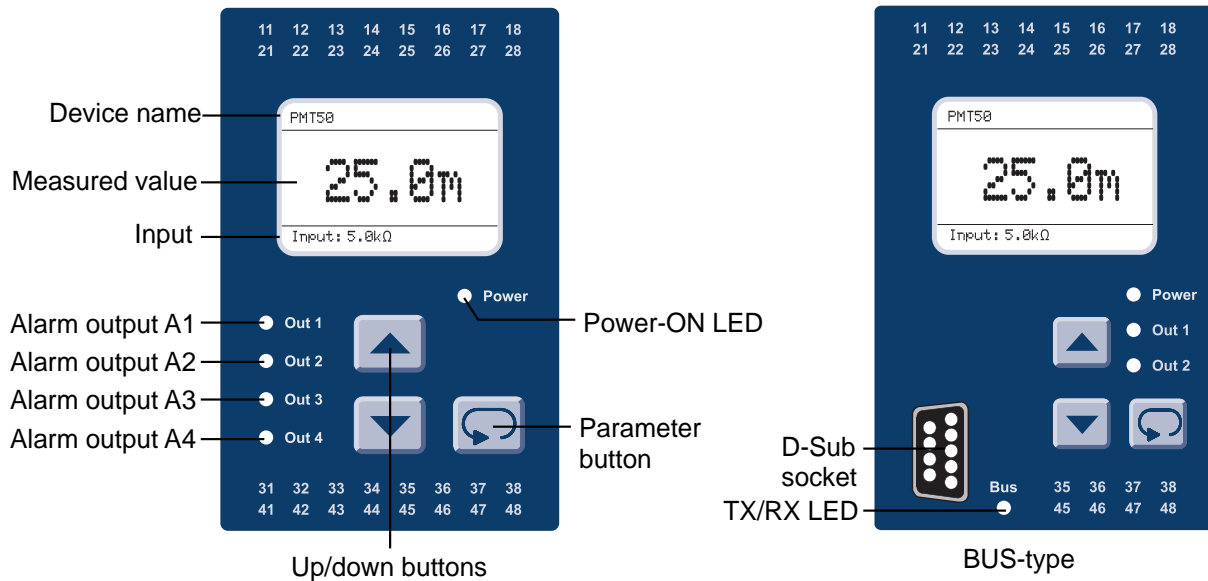

Description

The operation of the device is implemented in 2 levels. The required parameter is called up with the button . The selection within a parameter and the setting-adjustment of a value is implemented with the buttons and .

Button combinations (press buttons simultaneously):

- + 1 Parameter back
- + Parameter is set to "0" or minimum value.

After the switching on the supply voltage, the device initializes itself. In the display, the message indicating device type and software version is shown. After the initialization, the device is running in the working level. The peak value storage is called up and the setpoints of the alarm outputs can be programmed.

The configuration level is called up by activation of the button for 2 seconds. In this case, all parameters which determine the properties of the device are programmed. After the last menu item, or if no button is pressed for longer than 2 minutes, a skip-back into the working level is implemented automatically and the current measured value is indicated in the display. The configuration level can be exited at any time by holding down button for 2 seconds.

Error reports

In case of occurring faults, the messages are shown on the display in plain text. This simplifies location of the error. See explanation page 14.

Operational startup reference!

The device is preset with an ex-works default setting. Therefore it must be adapted to each special application. See Page 7.

Explanations for characteristic curve programming

Linear curve (see page 10)

The linear curve needs only one value pair for start- and end value. At this every input value, the corresponding display value has to be assigned. See example:

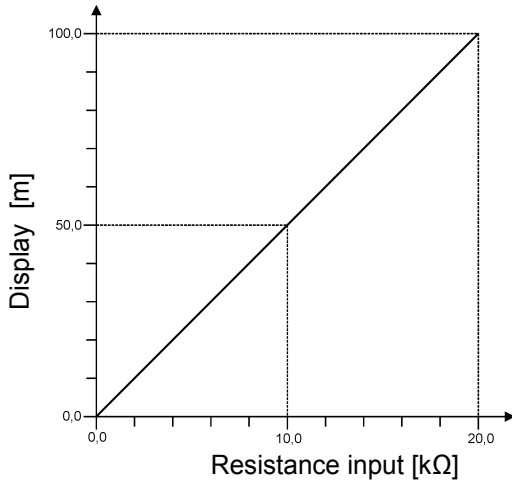

Example:

Input : Resistance
 Start value : 0.0 kΩ
 End value : 20.0 kΩ

Display : Height [m]
 Start value : 0.0 m
 End value : 100.0 m

In this example, 4 values for input and display range are needed. Every interem value belongs to the curve. Example: an input value of 10.0 kΩ is leading to the display value of 50.0 m.

Non linear curve (see page 10)

The non linear curve can have max. 32 value pairs for input and output to emulate the curve. At this, for every input value a display value can be programmed. Every interem value belongs to the curve.

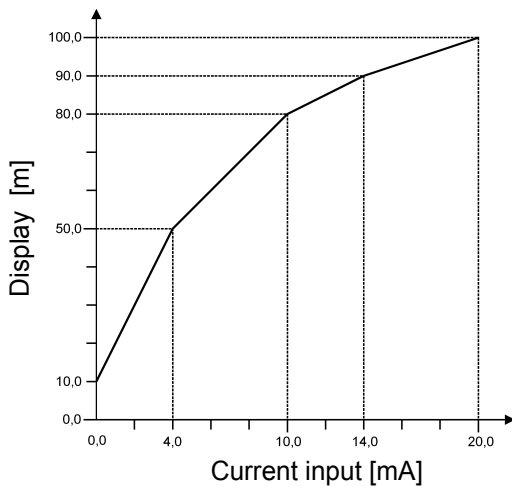

Example: curve with 5 base-points

Input : 0 ... 20 mA
 Display : 0.0 ... 100.0 m

Base-point	Input value	Display value
1	0.0 mA	10.0 m
2	4.0 mA	50.0 m
3	10.0 mA	80.0 m
4	14.0 mA	90.0 m
5	20.0 mA	100.0 m

The curve above shows clearly the classification between input signal and display value. This example has 5 value pairs. For every input value the corresponding display value has to be programmed. The procedure is finished, if the button  is pressed after the last base-point programming and OFF is selected in the following parameter.

At the teach-in programming no manually programming of the input values is necessary. At this, for the measured input values the actual values will be taken over. This method is ideal if the input signal is unknown but the corresponding display value is known (capacity gauging of tanks).

Note on the representation



Parameter appears only with corresponding configuration



Parameter appears only with corresponding equipment version

Working level

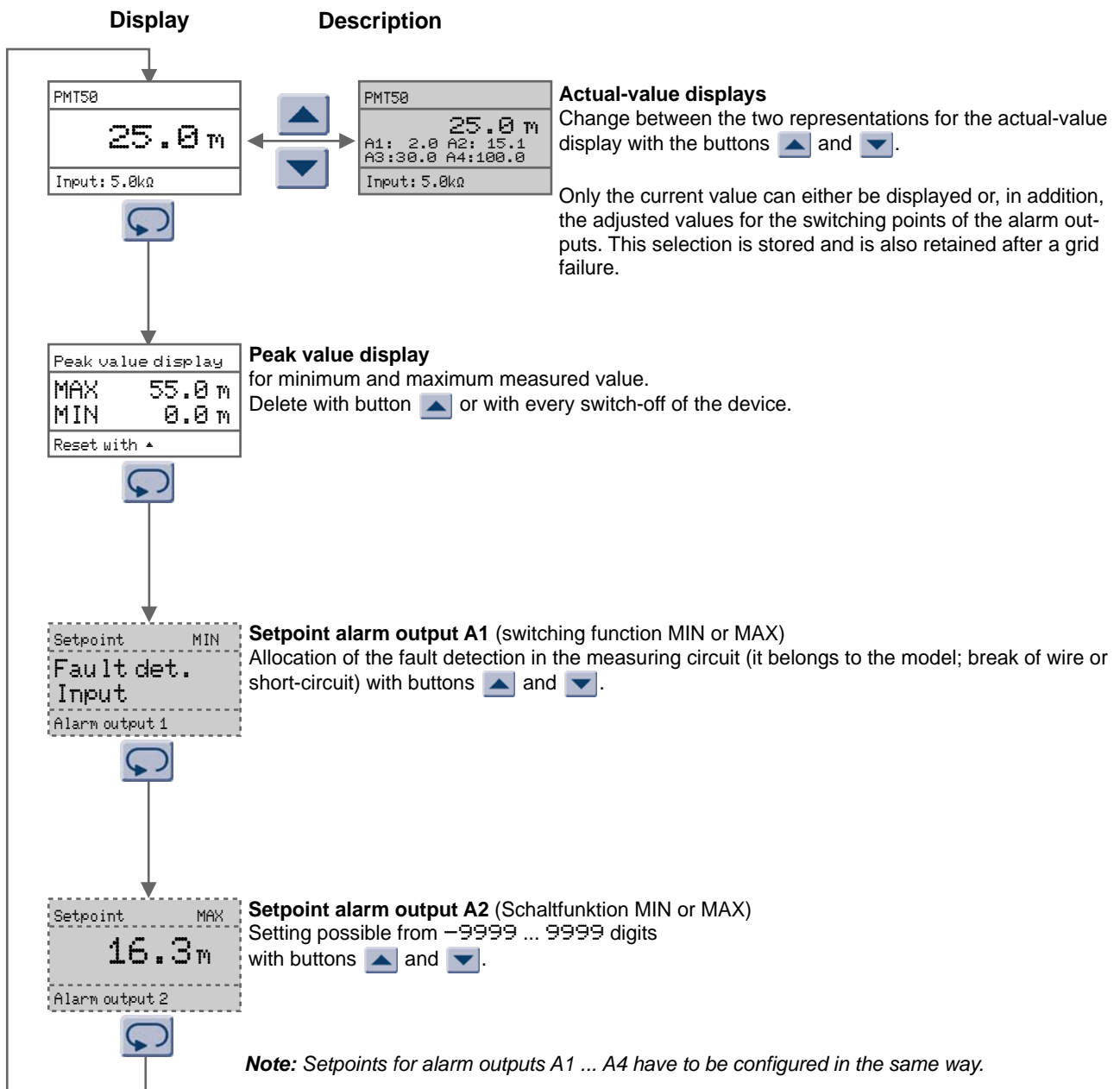

Configuration level

Display

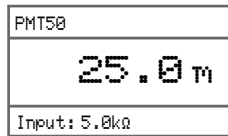

Press 2s

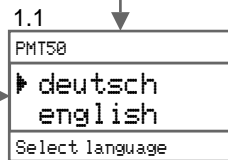
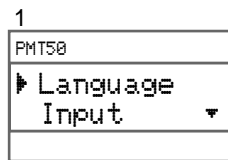

User Language

deutsch
english
Selection with buttons ▲ and ▼.

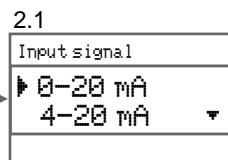
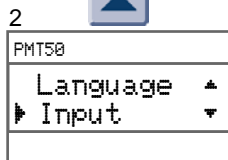

Input signal

For the different devices of the PMT50 are following input signals necessary:

Model 1	Model 2	Model 3
0 - 20 mA	Resistance	Pt100
4 - 20 mA	Poti	Pt1000
0 - 10 V DC		Thermo J
2 - 10 V DC		Thermo K
		Thermo N
		Thermo S

Selection with buttons ▲ and ▼.

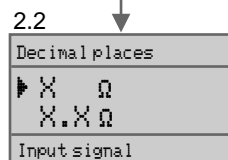

Decimal places resistance input

Parameter 2.2 is only available for model 2, if the input signal resistance is selected.

Selection possible with buttons ▲ and ▼.

The number of the decimal places belongs to the programming of the characteristic curve.

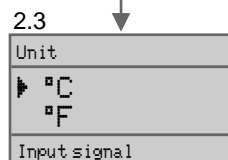

Unit temperature

Parameter 2.3 is only available for model 3.

Selection possible with buttons ▲ and ▼.

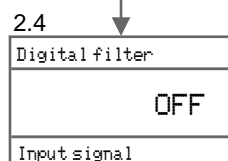

Digital filter

OFF or in steps of 0.5 s in the range from 0.5 ... 40s

Selection with buttons ▲ and ▼.

Continue page 8

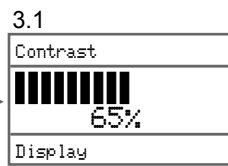
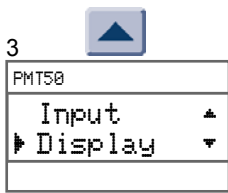

Display contrast

Setting possible from 0 ... 100% with buttons and .

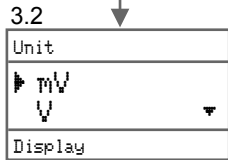

Display unit

The selected unit will be displayed and used for programming of the characteristic curve.

Installed units:

mV, V, mA, A, Ω, kΩ, μS/cm, mS/cm, °C, °F, min⁻¹, rpm, bar, mbar, hPa, kPa, mm, cm, m, %, °, l, l/min, m³, m³/h, ppm and custom.

custom = max. 5 characters are free programmable.

Selection with buttons and .

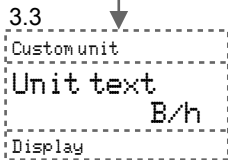

Custom unit

Only appears if custom is selected

Maximal 5 characters are programmable (see character set below).

Scrolling through the characters is possible

with buttons and .

The selected character will be entered with button . After that, the cursor jumps to the next position. Selection procedure as before. If 5 characters are entered or no more characters wanted, the parameter custom unit will be excited automatically.

Character set:

_ A B C D E F G H I J K L M N O P Q R S T U V W X Y Z

a b c d e f g h i j k l m n o p q r s t u v w x y z

ä ö ü ß

. ? ! , : _ % / \ + - * [] () < = > " • ◀ ▶ ↕ ↘ ↙ ◀ ▶ ▲ ▼ °

μ Ω Δ ^{1 2 3} -^{1 -2}

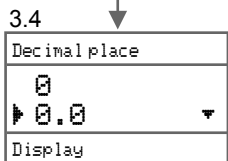

Number of decimal places

For the different models are following decimal places selectable:

Model 1: 0; 0.0; 0.00; 0.000

Model 2: 0; 0.0; 0.00; 0.000

Model 3: 0; 0.0

Selection with buttons and .

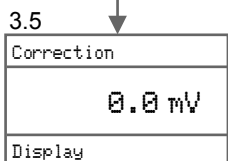

Display correction

Correction of the displayed value.

Setting possible from -9999 ... 9999 Digit

with buttons and .

Continue page 9

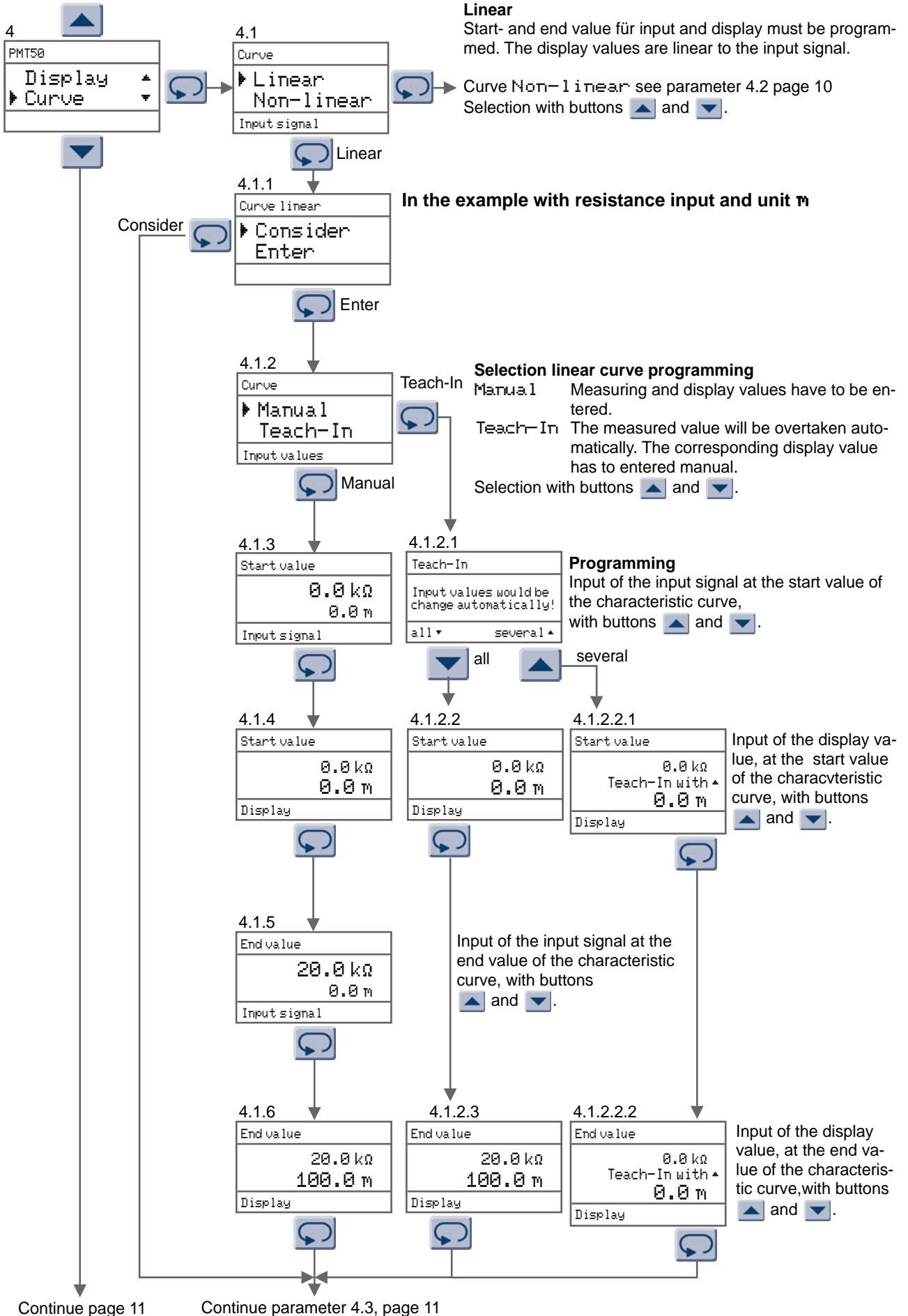

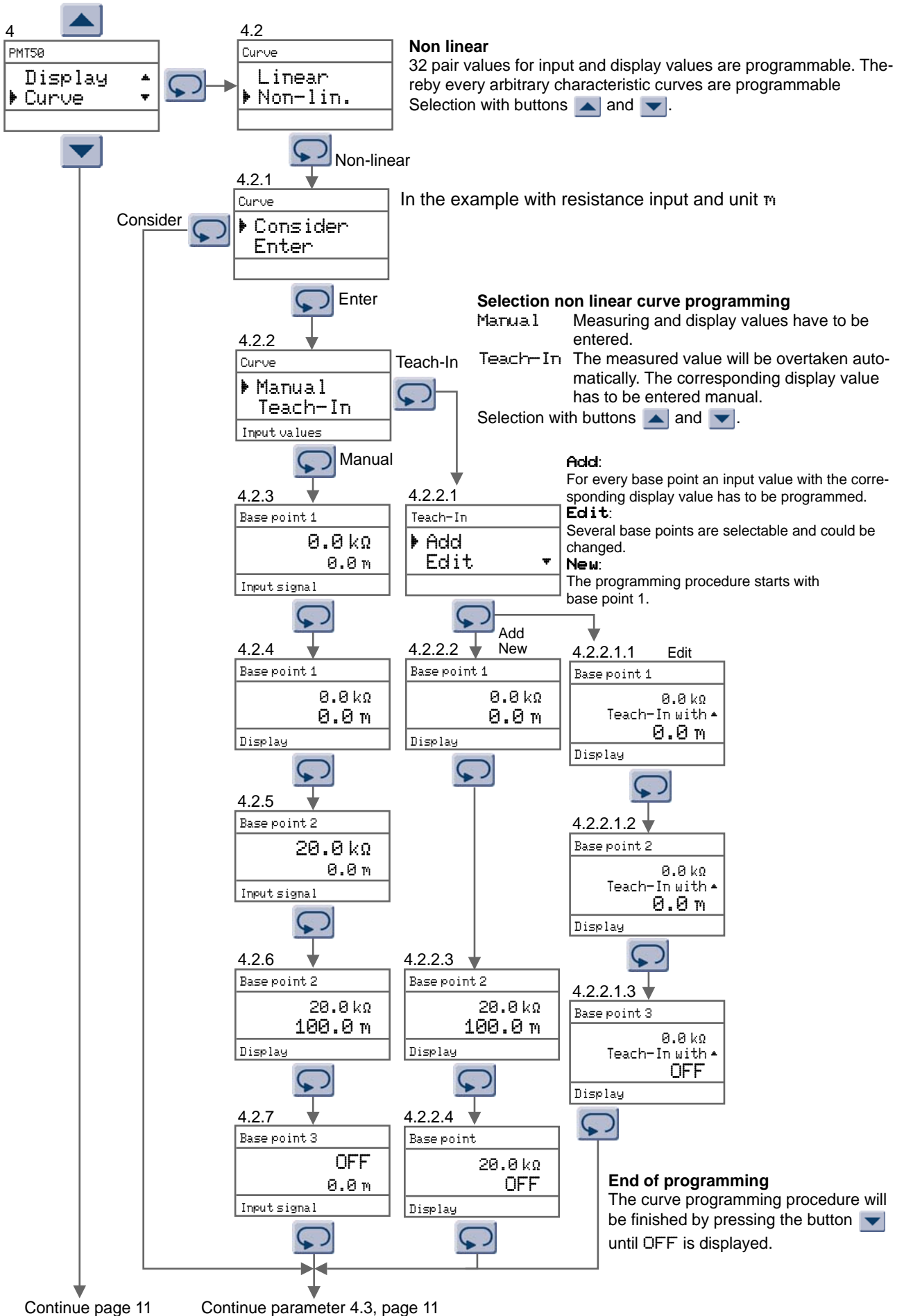

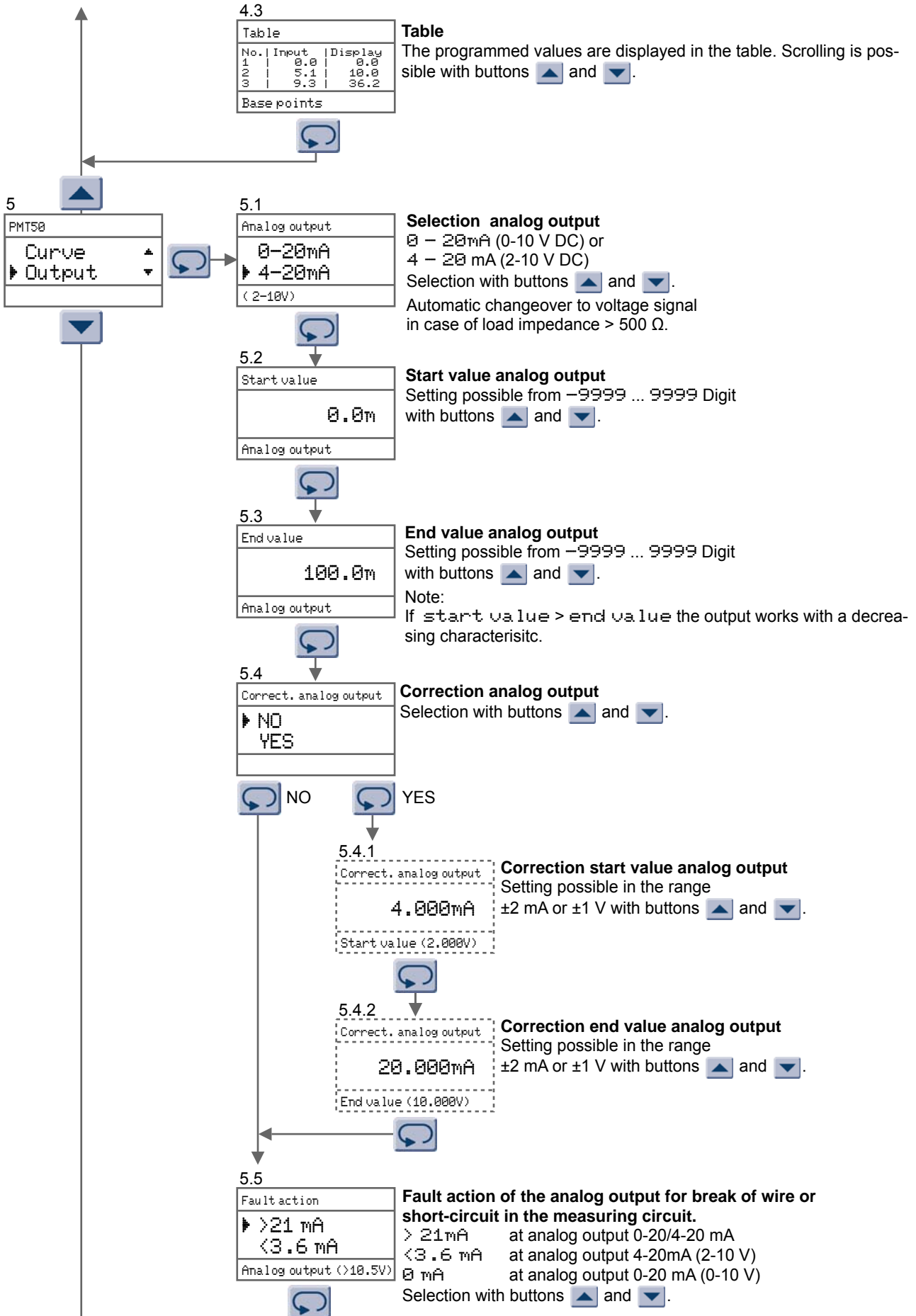

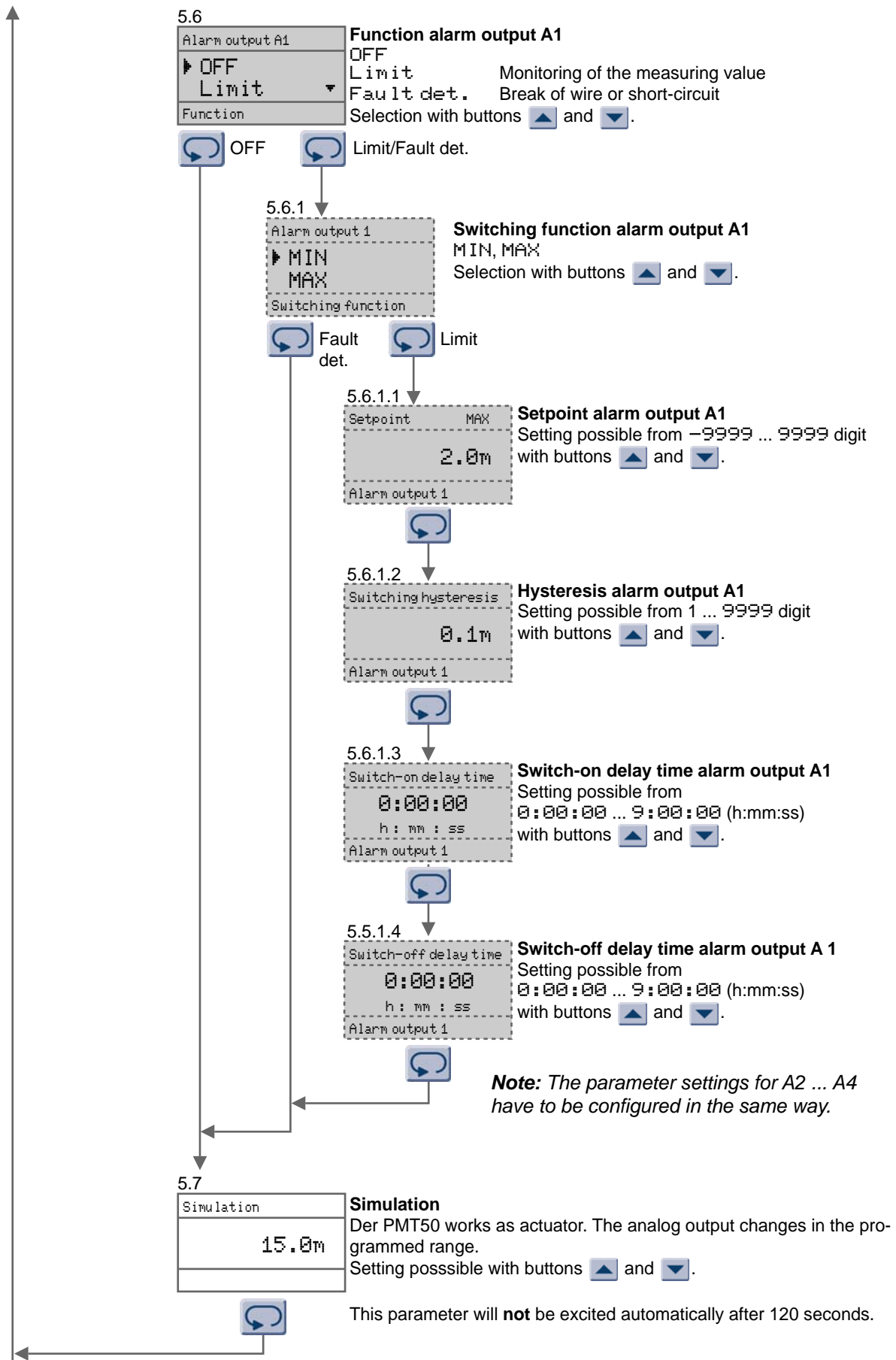

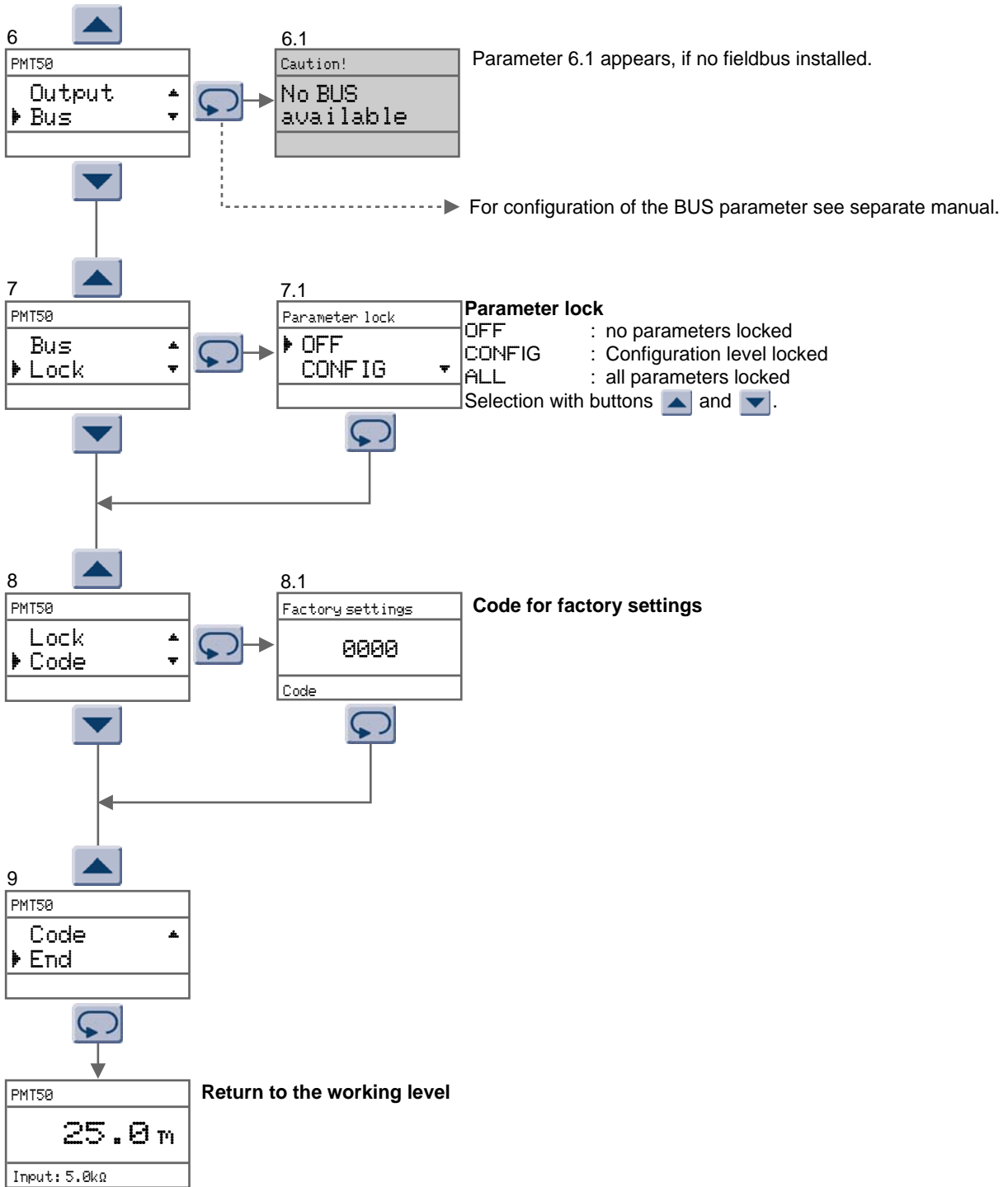



Error reports

Description

Caution!
Parameter locked
switched on

The parameter can not be changed, because the parameter lock for the configuration level, or work and configuration level, is switched on.

Caution!
Undervoltage

Supply voltage to low

Caution!
XX Parameter error
Please check

At the check-up of the parameter memory, XX errors are detected. The incorrect parameters are reset to the factory settings. Please check and correct parameters if necessary.

Caution!
XX Parameter error
Calibration necessary

As before, but the factory settings are incorrect. The device must be checked at work.

Change of decimals?
Some parameters not representable! Adapt parameters automatically?
▲ Yes ▼ No

Change of decimal places

While changing number of decimal places, some parameters can be converted, but however, not represented!

Selection "No" : Change of the decimal places is not carried out.

Selection "Yes" : Decimal places are changed automatically, where the affected parameters are set to the maximum possible value. A subsequent verification of the accepted parameters is absolutely necessary.

Caution!
Input value for this base point would be assigned be- fore.
Please change input value!

At the base-point programming the input value is assigned to an display value before.

PMT50
Fault input
Input: 999.9kΩ

Break of wire or short-circuit in the measuring circuit.
Text Input: 999.9kΩ is flashing.

Ordering code

PMT50 - 1. - 2. - 3. - 4. - 5. - 6.

1. Model/Input

1	Standard signals 0/4 ... 20 mA; 0/2 ... 10 V DC		
2	Resistance from 0 ... 100 kΩ, Poti 1 kΩ ... 100 kΩ		
3	Pt100	3-wire	-100.0 ... 600.0 °C/-100 ... 600 °C
	Pt1000	3-wire	-100.0 ... 300.0 °C/-100 ... 300 °C
	Thermocouple	J (Fe-CuNi)	-100.0 ... 800.0 °C/-100 ... 800 °C
		K (NiCr-Ni)	-150 ... 1200 °C
		N (NiCrSi-NiSi)	-150 ... 1200 °C
S (Pt10Rh-Pt)	-50 ... 1600 °C		

2. Analog output

AO 0/4 ... 20 mA, 0/2 ... 10 V DC, galv. isolated

3. Alarm outputs

00	not installed	
2R	2 relay outputs	A1, A2 SPDT

4. Alarm outputs/BUS configuration

00	not installed	
2R	2 relay outputs	A3, A4 SPDT
MB	Modbus RTU/ASCII	RS485
PB	Profibus DP	

5. Supply voltage

0	230 V AC	± 10 %	50-60 Hz
1	115 V AC	± 10 %	50-60 Hz
5	24 V DC	± 15 %	

6. Options

00 without option

Custom configuration