

Temperature-Guard TG 50

Pt100/Pt1000 - Thermocouple J, K, N, S

Features

- Input
Pt100, Pt1000 and Thermocouples J, K, N, S
- Measuring range programmable
- Basic accuracy 0.1 % +/- 1 Digit
- Simulator function
- Fault monitoring for break of wire and short-circuit in the measuring circuit
- Programmable fault function
Analog output min. or max. overflow
Alarm outputs min. or max. function
- 4 alarm outputs, relay SPDT
- Isolated analog output 0/4 ... 20 mA; 0/2 ... 10 V DC
- Full 3-port isolation



General

The Temperature-Guard TG50 has inputs for temperature probes RTD (Pt100/Pt1000) and thermocouple J, K, N and S. Simple programming, up to 4 alarm outputs (SPDT) and optional available fully isolated free programmable analog output 0/4 ... 20 mA; 0/2 ... 10 V DC offers a lot of solutions for temperature monitoring. Peak value indication for minimum and maximum measured temperature are stored in the background and can be read out from the display at any time.

Short information

Programming	The device is programmed by frontal buttons, in connection with the LCD display.
Inputs	RTD (Pt100/Pt1000), 3-wire connection or thermocouple type J, K, N or S.
Alarm outputs	The alarm outputs can be programmed as max. or min. function. Switch-on delay and switch-off delay time is programmable from 1 s up to 9 h. The switching status is displayed through LED's.
Fault function	A fault in the measuring circuit could be monitored (break of wire/short-circuit). The switching function of the analog and alarm output(s) is programmable in case of an fault.

Technical data

Power supply

Supply voltage : 230 V AC $\pm 10\%$, 115 V AC $\pm 10\%$, or 24 V DC $\pm 15\%$
 Power consumption : < 5 VA
 Operating temperature : -10 ... 55 °C (14 ... 131 °F)
 Rated voltage : 250 VAC acc. to EN 60664-1 between
 input/relay output/analog output/supply voltage
 degree of pollution 2, overvoltage category III

Test voltage : 4 kV DC between input/relay output/analog output/supply voltage

CE -conformity

Standardize IEC61326 05/2004			Result
IEC 61000-4-2 (ESD) IEC 61000-4-3 (E-field) IEC 61000-4-8 (Magnetic filed)	Case	4 kV/8 kV contact/air 10 V/m 30 A/m	B A dispensed with
IEC 61000-4-11 (Voltage dip) IEC 61000-4-4 (Burst) IEC 61000-4-5 (Surge) IEC 61000-4-6 (HF current feed)	AC power supply connection	0.5 period, $\pm 100\%$ 2 kV 1 kV L/N, 2 kV L,N/PE 3 V	A A A A
IEC 61000-4-4 (Burst) IEC 61000-4-5 (Surge) IEC 61000-4-6 (HF current feed)	DC power supply connection	2 kV 1 kV L/N, 2 kV L,N/PE 3 V	A A A
IEC 61000-4-4 (Burst) IEC 61000-4-5 (Surge) IEC 61000-4-6 (HF current feed)	Input/output, signal/control	1 kV 1 kV L/N/PE 3 V	A B A
CISPR16-1/16-2	Radiated interference		Passed

Inputs

Fault detection : Break of wire (RTD, Thermocouple) and short-circuit (only RTD)

Input : Pt100 (3-wire) -100.0 ... 600.0 °C / -100 ... 600 °C
 Pt1000 (3-wire) -100.0 ... 300.0 °C / -100 ... 300 °C
 : Thermo couple (TC)
 Type J -100.0 ... 800.0 °C / -100 ... 800 °C
 Type K -150 ... 1200 °C
 Type N -150 ... 1200 °C
 Type S -50 ... 1600 °C
 cold junction compensation integrated

Basic accuracy : <0.1 %, ± 1 Digit

Temperature coefficient : 0.01 %/K

Outputs

Alarm outputs A1-A4 : Relay SPDT < 250 V AC < 250 VA < 2 A $\cos\phi \geq 0.3$, < 300 V DC < 40 W < 2 A

Analog output : 0/4 ... 20 mA burden $\leq 500 \Omega$; 0/2 ... 10 V burden $> 500 \Omega$, galv. isolated,
 output changes automatically (burden impedance dependent)

Fault function : For break of wire or short-circuit detection -belongs to the model-
 → Analog output 0 mA, < 3.6 mA or > 21.5 mA programmable
 → Alarm output(s) min. or max. function programmable

Display

: Graphic LCD-Display 128x64 pixel, white background illuminated

Case

: Polyamide (PA) 6.6, UL94V-0, DIN rail mounting TS 35

Weight : approx. 450 g

Connection : Screw terminals 0.14 ... 2.5 mm² (AWG 26 .. 14)

Protection : Case IP30, terminals IP20, German BGV A3

Connection diagram

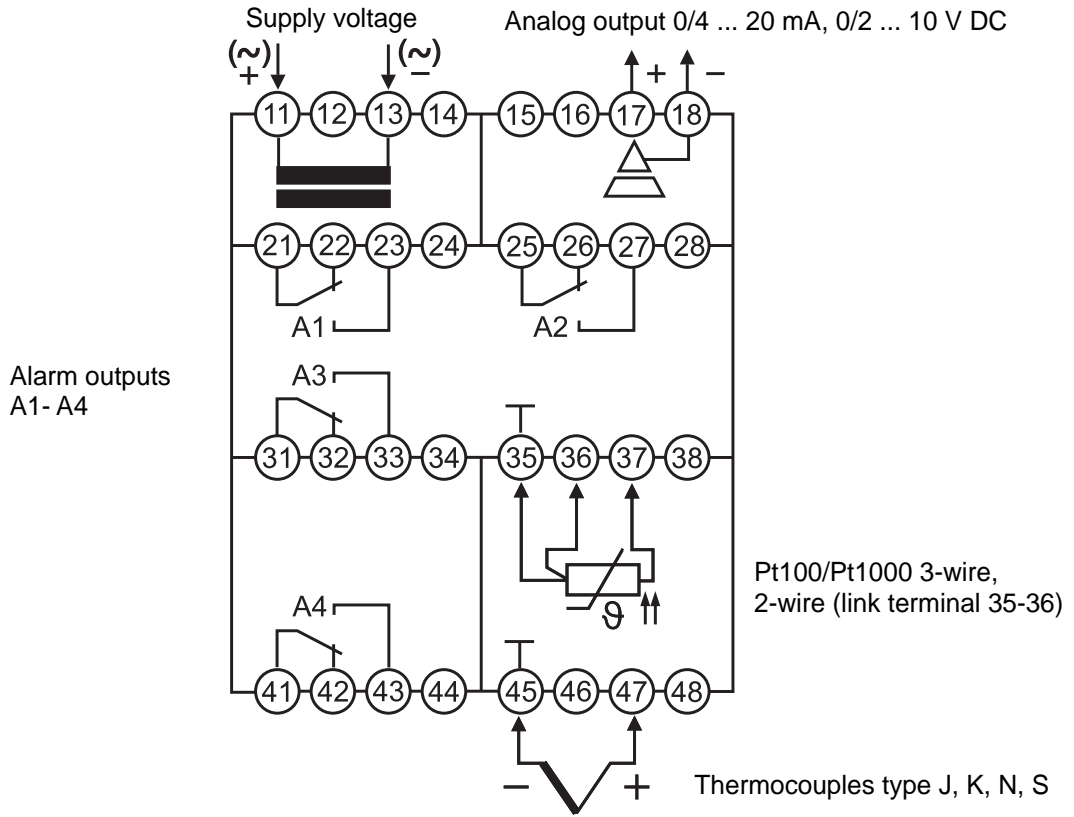

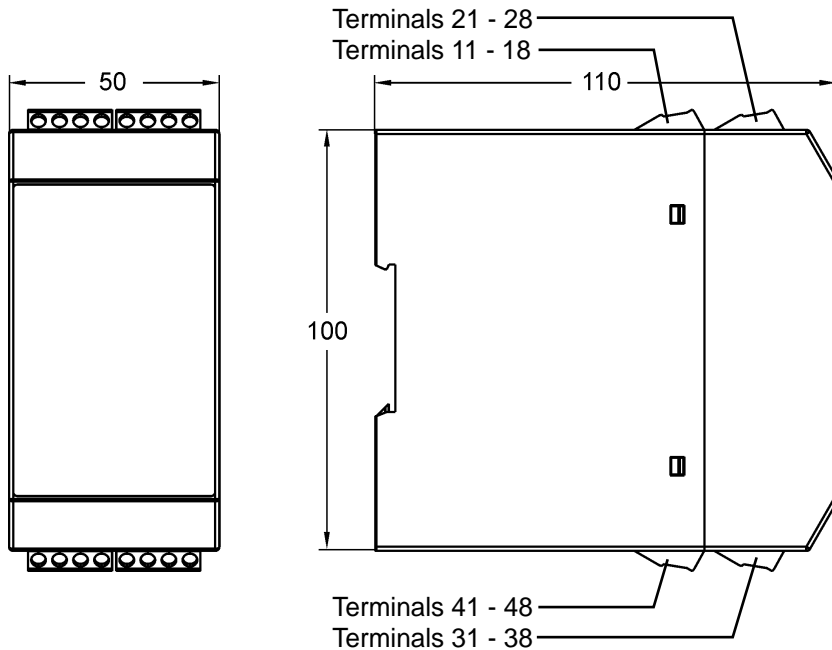

Dimensions



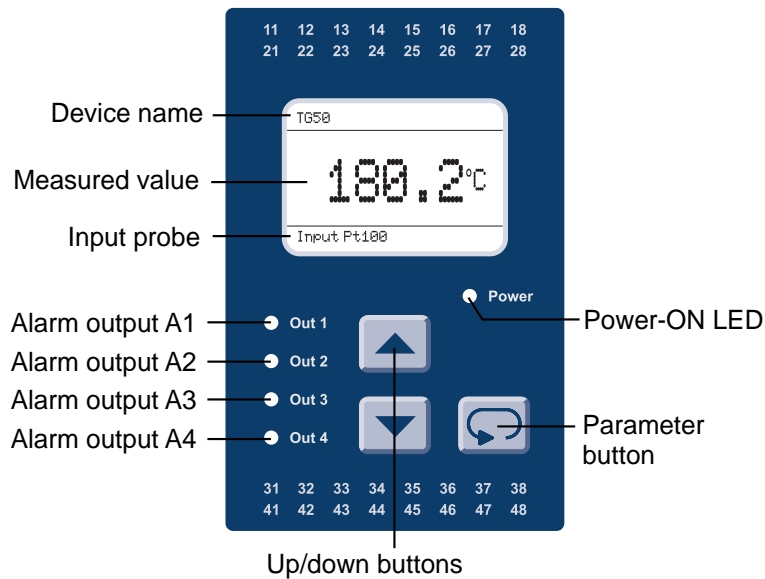



Controls and indicators





Description

The operation of the device is implemented in 2 levels. The required parameter is called up with the button . The selection within a parameter and the setting-adjustment of a value is implemented with the buttons  and .

Button combinations (press buttons simultaneously):

-  +  1 parameter back
-  +  Parameter is set to "0" or minimum value.

After the switching on the supply voltage, the device initializes itself. In the display the message indicating device type and software version is shown. After the initialization, the device is running in the working level. The peak value storage is called up and the setpoints of the alarm outputs can be programmed.

The configuration level is called up by activation of the button  for 2 seconds. In this case, all parameters which determine the properties of the device are programmed. After the last menu item, or if no button is pressed for longer than 2 minutes, a skip-back into the working level is implemented automatically and the current measured value is indicated in the display. The configuration level can be exited at any time by holding down button  for 2 seconds.

Error reports

In case of occurring faults, the messages are shown on the display in plain text. This simplifies location of the error. See explanation page 10.

Operational startup reference!

The device is preset with an ex-works default setting. Therefore it must be adapted to each special application. See Page 6.

Note on the representation



Parameter appears only with corresponding configuration



Parameter appears only with corresponding equipment version

Working level

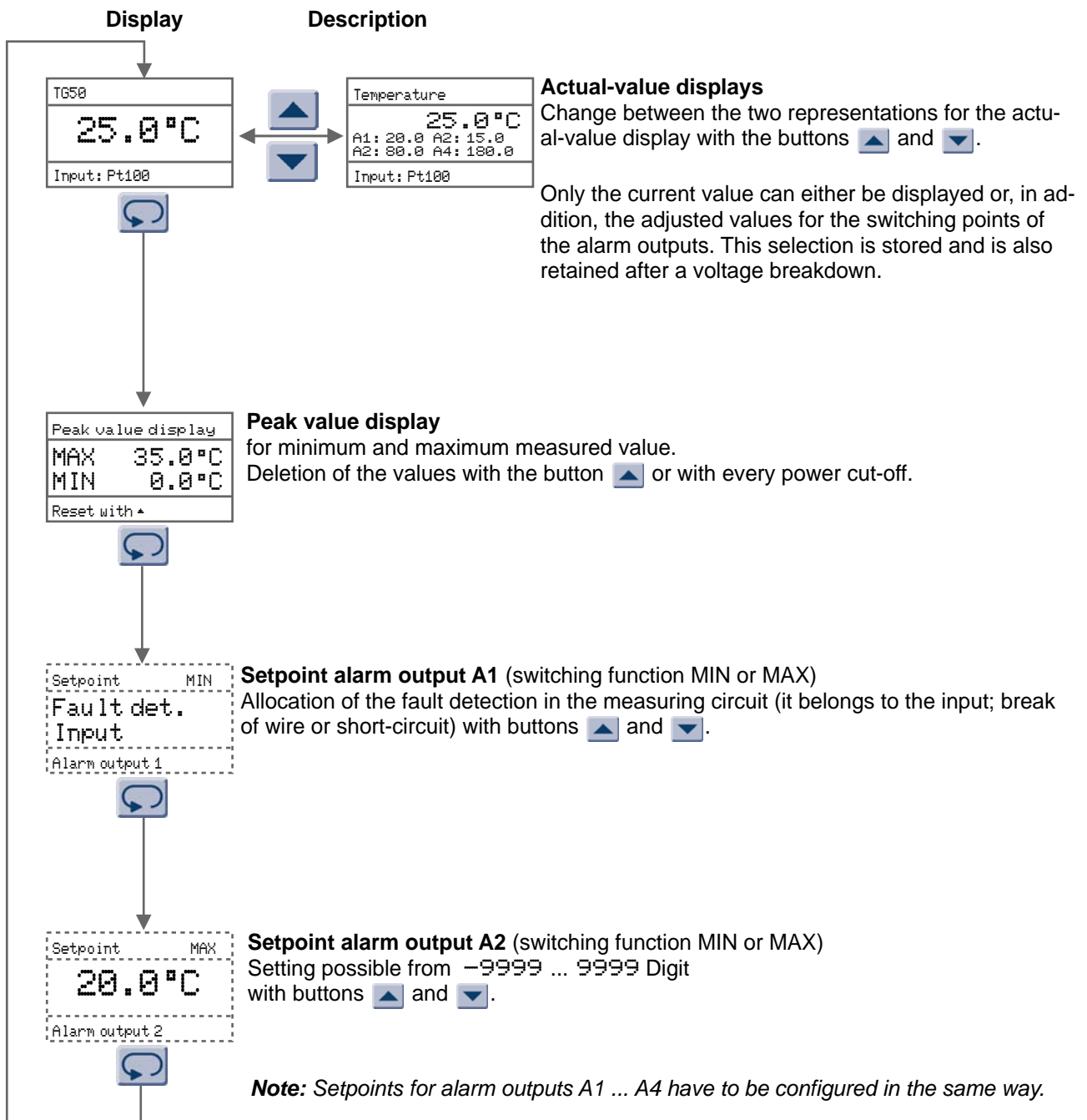

Configuration level

Display

Description (represented values are default settings)

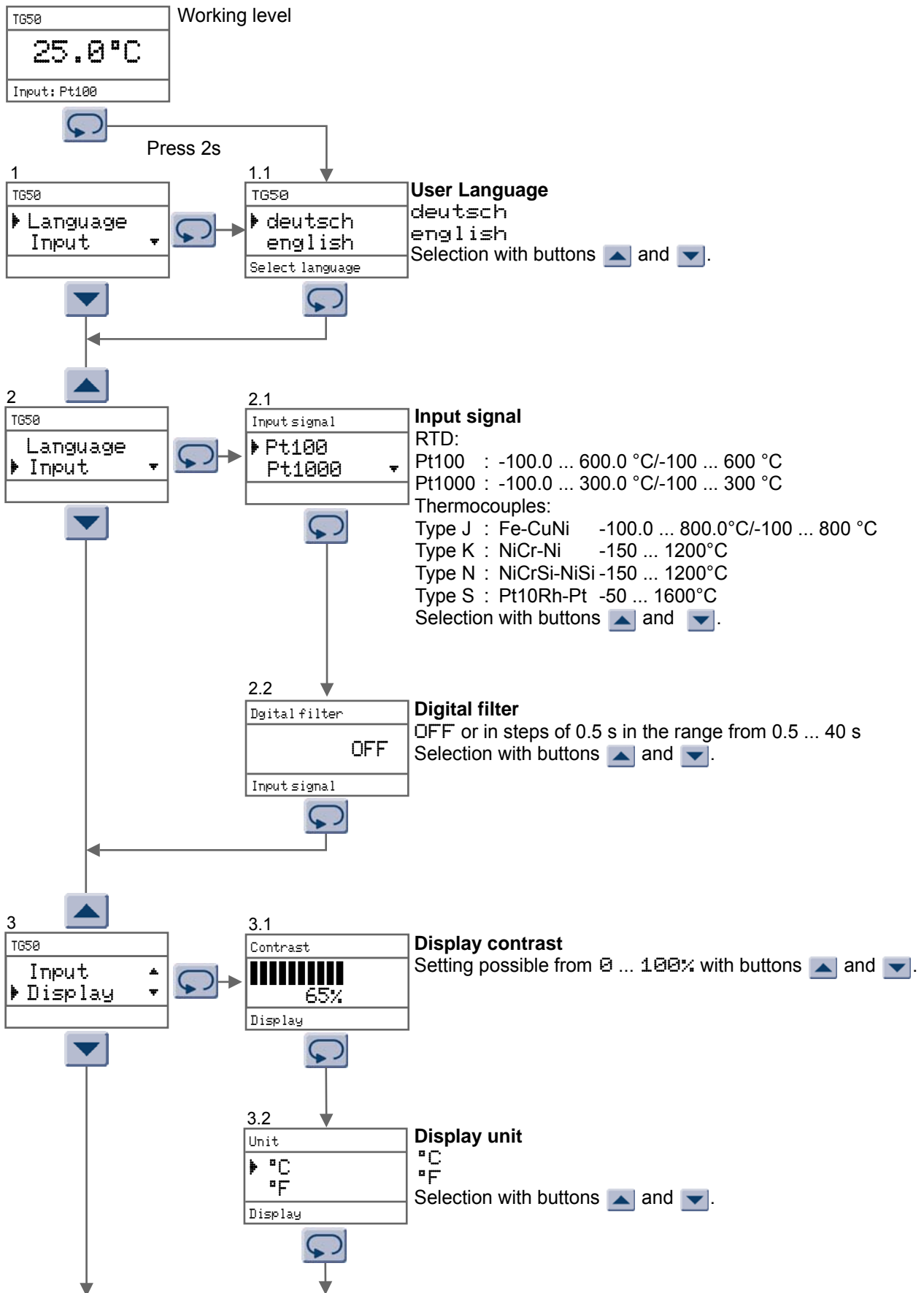

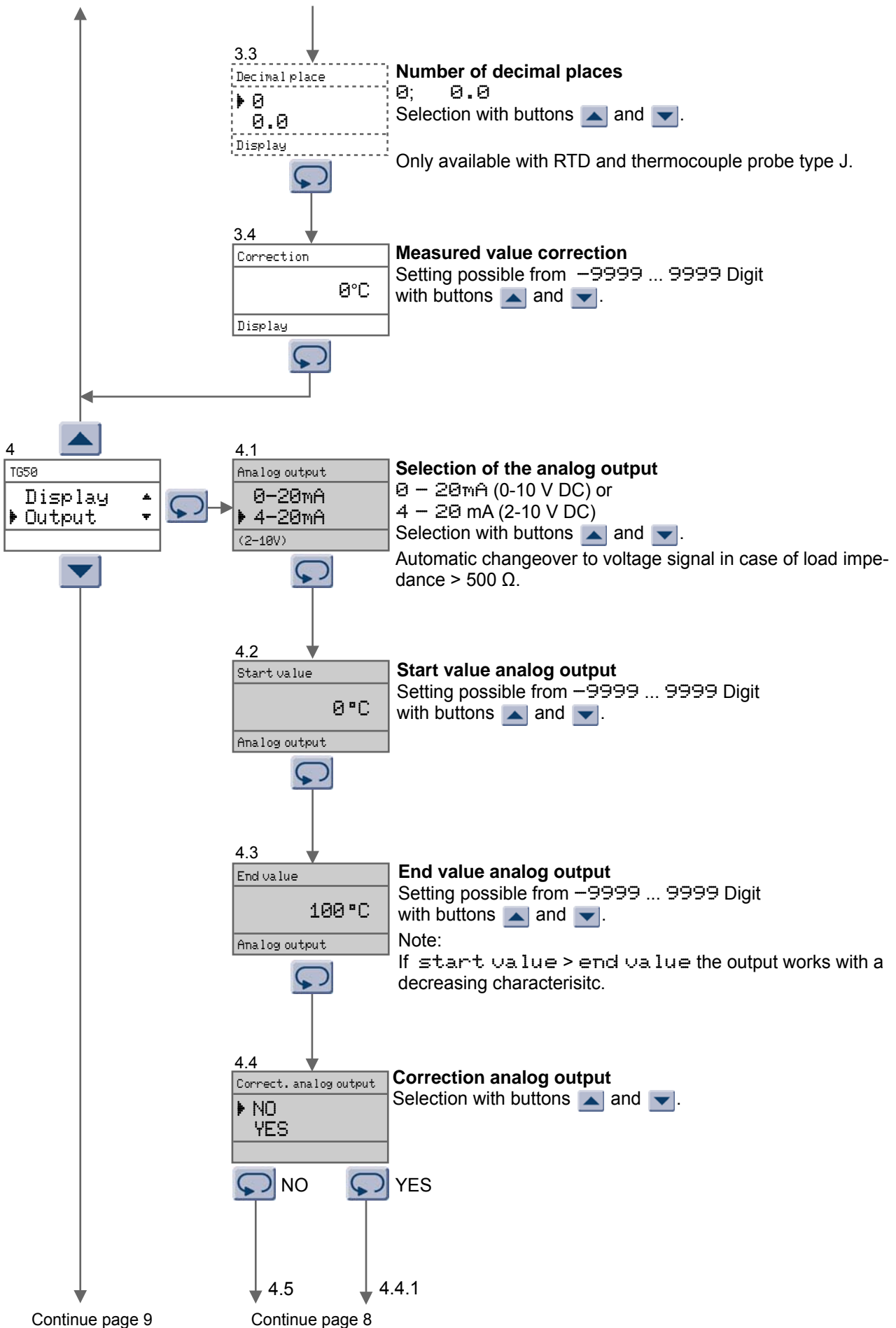

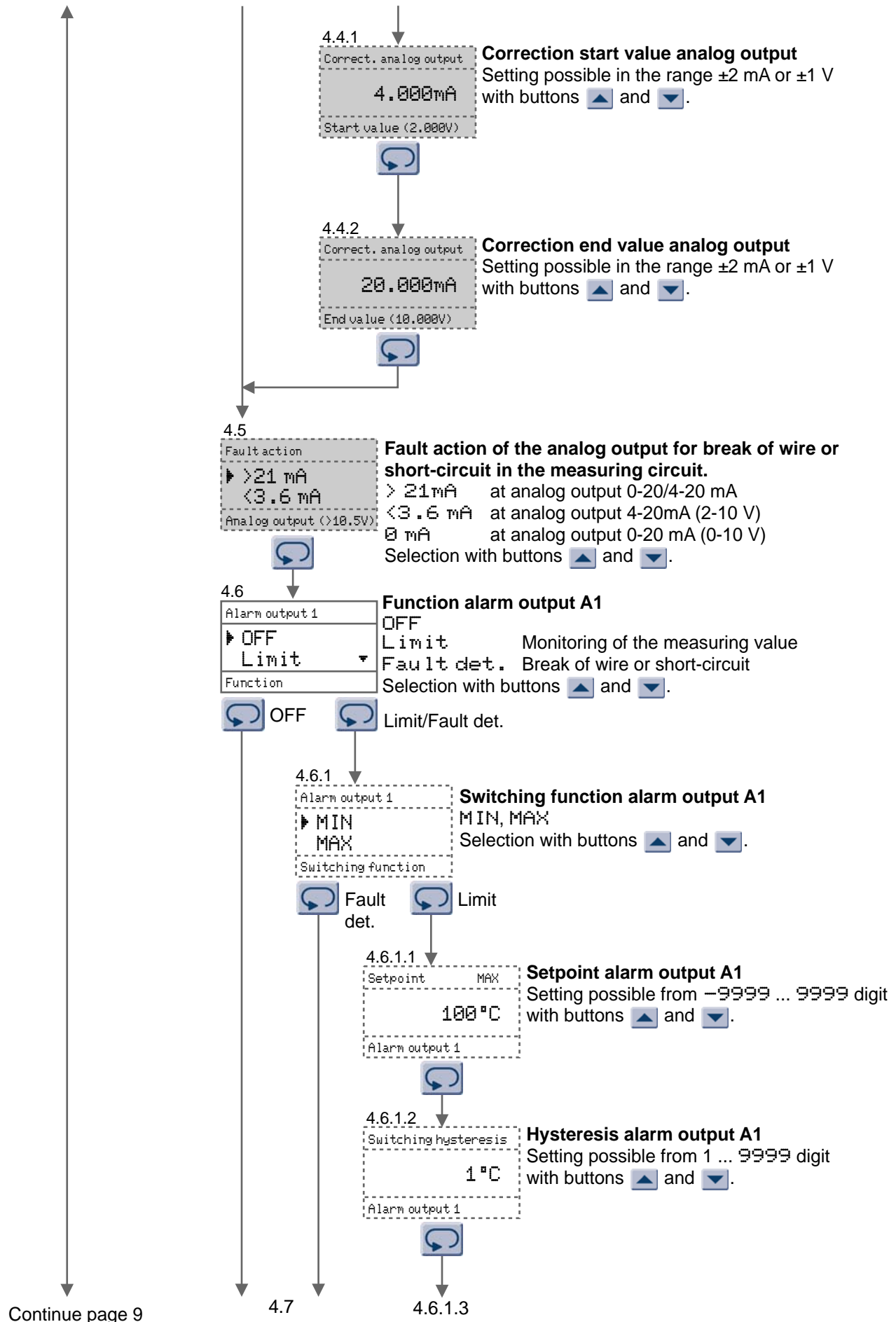

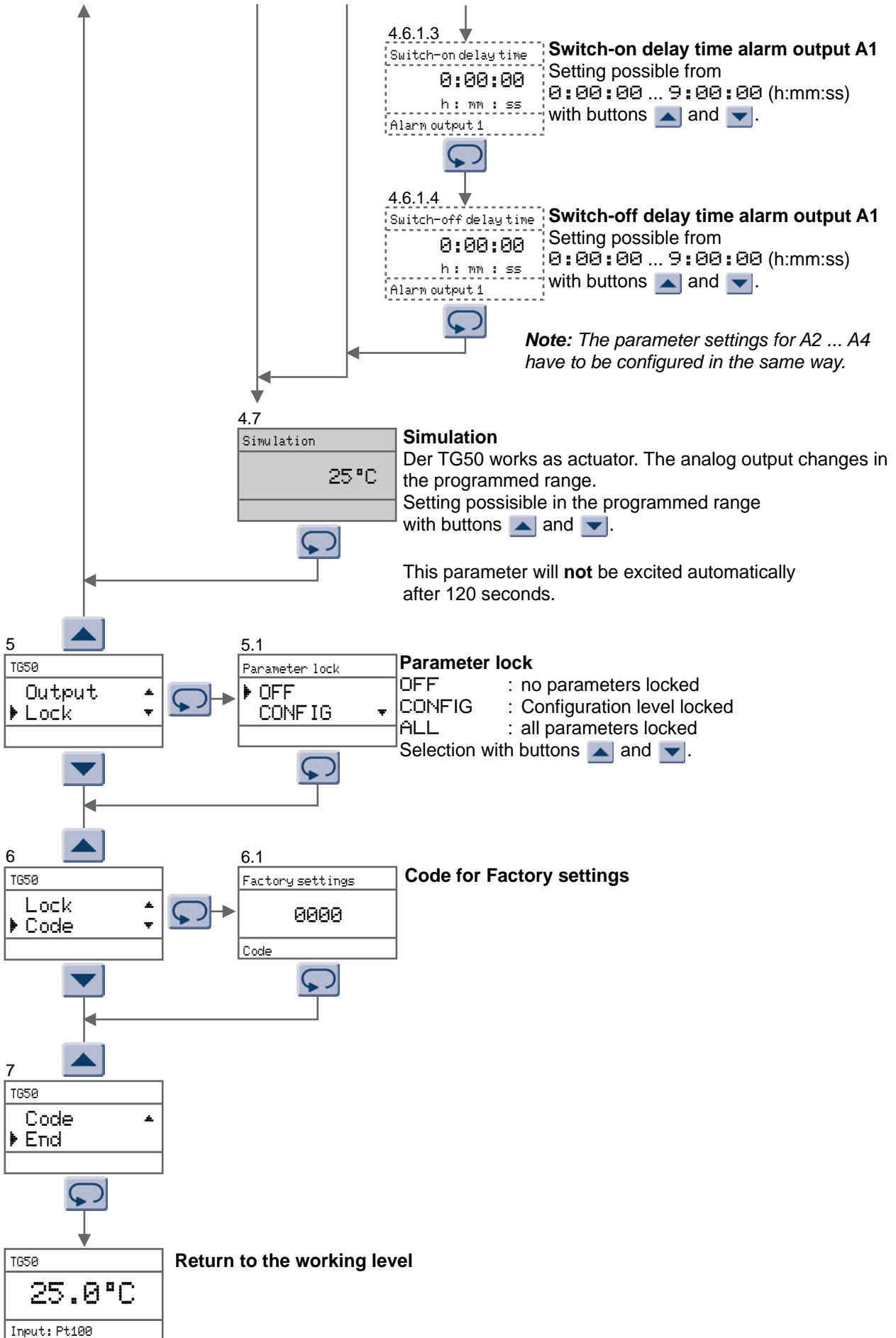

Error reports

Description

Caution!
Parameter locked
switched on

The parameter can not be changed, because the parameter lock for the configuration level, or work and configuration level, is switched on.

Caution!
Undervoltage

Supply voltage to low

Caution!
XX Parameter error
Please check

At the check-up of the parameter memory, XX errors are detected. The incorrect parameters are reset to the factory settings. Please check and correct parameters if necessary.

Caution!
XX Parameter error
Calibration necessary

As before, but the factory settings are incorrect. The device must be checked at work.

Change of decimals?
Some parameters not representable! Adapt parameters automatically?
▲ Yes ▼ No

Change of decimal places

While changing number of decimal places, some parameters can be converted, but however, not represented!

Selection "No" : Change of the decimal places is not carried out.

Selection "Yes" : Decimal places are changed automatically, where the affected parameters are set to the maximum possible value. A subsequent verification of the accepted parameters is absolutely necessary.

T658
Fault input
Input: 9999°C

Break of wire or short-circuit in the measuring circuit.

Text Input: 9999°C is flashing.



Ordering code

TG50 - 1. - 2. - 3. - 4. - 5. - 6.

1. Input

3	Pt100	3-wire	-100.0 ... 600.0 °C/-100 ... 600 °C
	Pt1000	3-wire	-100.0 ... 300.0 °C/-100 ... 300 °C
	Thermocouple	J (Fe-CuNi)	-100.0 ... 800.0 °C/-100 ... 800 °C
		K (NiCr-Ni)	-150 ... 1200 °C
		N (NiCrSi-NiSi)	-150 ... 1200 °C
		S (Pt10Rh-Pt)	-50 ... 1600 °C

2. Alarm outputs

2R 2 Relay outputs A1, A2; SPDT

3. Alarm outputs

00 not installed
 2R 2 Relay outputs A3, A4; SPDT

4. Analog output

00 not installed
 AO Analog output 0/4 ... 20 mA; 0/2 ... 10 V DC

5. Supply voltage

0	230 V AC	± 10 %	50-60 Hz
1	115 V AC	± 10 %	50-60 Hz
5	24 V DC	± 15 %	

6. Options

00 without option

Works configuration according to customer specifications.