

# Standard-Signal-Panelmeter S 9648

Industry standard signals - integrated transmitter-supply - potentiometer

## Features

- LED-Display 14.2 mm red
- Display range  $\pm 9999(0)$  Digit
- Indicating range and decimal point free programmable
- 2<sup>nd</sup> measuring input for difference, average value
- Max. 4 outputs, SPDT relays or transistor
- Isolated analog output 0/4 ... 20 mA and 0/2 ... 10 V DC
- Front protection IP65



## General

The Standard-Signal-Panelmeter S9648 has been designed for measuring industry standard signals 0/4 ... 20 mA or 0 ... 10 V DC. The device offers an integrated transmitter supply for direct connection of 2- and 3-wire transmitters for e.g. pressure or temperature. The connection of potentiometers is possible as well. Indicating range and decimal point are free programmable in the range  $\pm 9999$  (standard) or  $\pm 99990$  (fixed zero selected).

## Short information

Programming	Parameters are programmed via front-side membrane keypad.
Alarm outputs	Switching performance min. or max., hysteresis, on-delay time and off-delay time are programmable in range from 1 s up to 9 h.
Digital filter	With activated digital filter last 16 measured values will be averaged continuously and the result shown in the display.
Analog output	Proportional to the input signal an isolated analog output signal 0 ... 20 mA/0 ... 10 V DC or 4 ... 20 mA/2 ... 10 V DC can be generated. Output changes automatically from current signal to voltage signal depending on burden.
2nd measuring input*	The device can be offered with a 2nd measuring input at the terminal strip B, for measuring difference-, average value, smaller or larger value. Please ask for further information.

\*Note: no isolation between input 1 (terminal strip A) and 2nd measuring input

## Technical data

### Supply power

Supply voltage	: 230 V AC $\pm 10\%$ ; 115 V AC $\pm 10\%$ , 24 V AC $\pm 10\%$ or 24 V DC $\pm 15\%$
Power consumption	: max. 3.5 VA, with analog output 5 VA
Operating temperature	: -10 ... +55 °C
Rated voltage	: 250 V ~ acc. VDE 0110 between input/output/supply voltage Degree of pollution 2, over-voltage categoric III
Test voltage	: 4 kV=, between input/output/supply voltage
CE - conformity	: EN55022, EN60555, IEC61000-4-3/4/5/11/13

### Input

Current input	: 0/4 ... 20 mA	Ri = 10 $\Omega$
Voltage input	: 0 ... 10 V	Ri = >100 k $\Omega$
Potentiometer	: 0 ... 1 k $\Omega$ /100 k $\Omega$	
Accuracy	: < 0.1 % $\pm 2$ Digit	
Temperature coefficient	: 0.004 %/K	
Transmitter-supply	: U <sub>0</sub> appr. 24 V, Ri appr. 150 $\Omega$ , max. 50 mA (25 mA with 4 relay outputs)	

Display	: LED red, 14.2 mm
Display range	: $\pm 9999(0)$ digit, leading zero suppression.
Parameter display	: LED 2-digit red, 7 mm (parameter - and output indicator)

### Output

Relay	: SPDT < 250 V AC < 250 VA < 2 A, < 300 V DC < 50 W < 2 A
Transistor	: max. 35 V AC/DC max. 100mA, short circuit protected
Analog output	: 0/4 ... 20 mA burden $\leq 500 \Omega$ ; 0/2 ... 10 V burden >500 $\Omega$ , isolated Automatic output changing (burden dependent)
-Accuracy	: 0.1%; TK 0.01%/K

Panel case	: DIN 96x48 mm, material PA6-GF; UL94V-0
Dimensions	: Front 96x48 mm, mounting depth 100 mm
Weight	: max. 390 g
Electrical connection	: Clamp terminals, 2 mm <sup>2</sup> single wire, 1.5 mm <sup>2</sup> flexible wire, AWG14
Protection	: Front IP65, terminals IP20, fingersafe acc. German BGV A3

## Dimensions

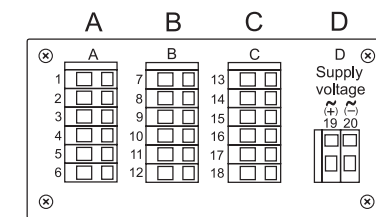
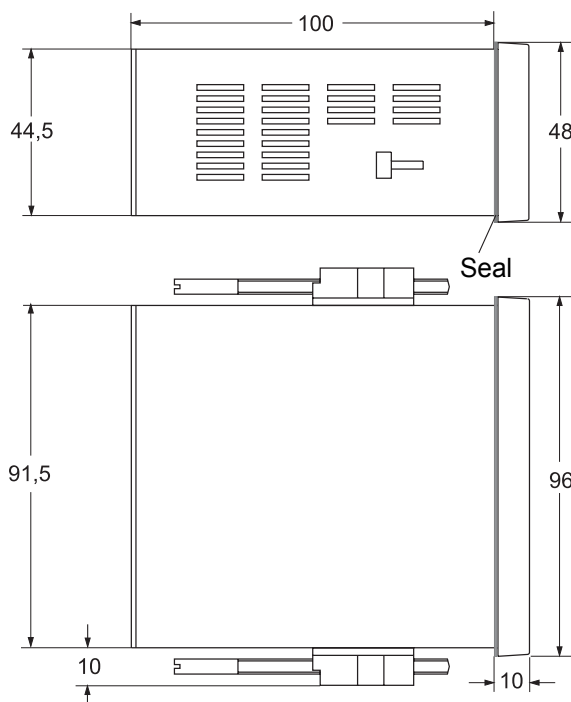

Terminal strip position

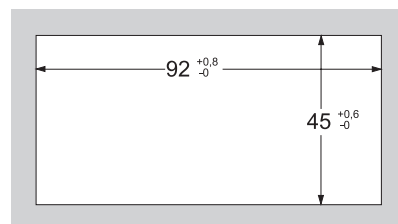

Panel cut-out acc. to  
DIN 43700-96x48

# Connection diagrams

## Terminal strip A

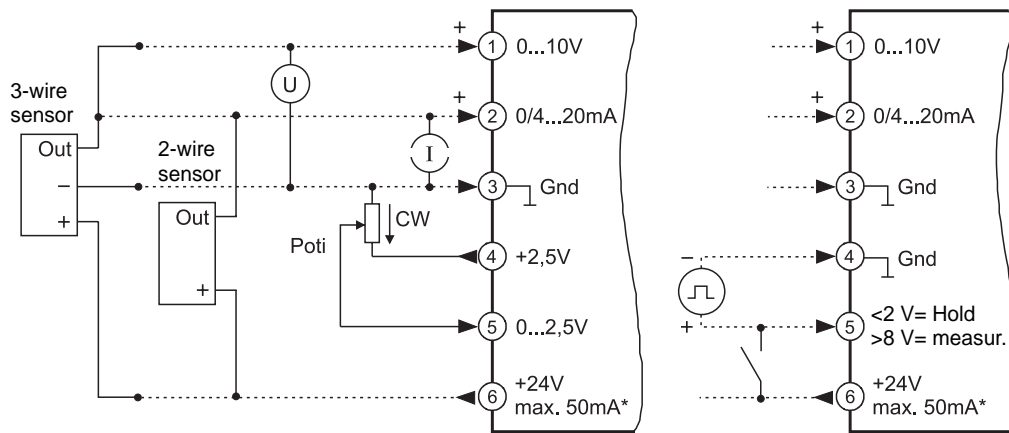

\*Transmitter supply

## Terminal strip B (varies with version)

2 alarm outputs

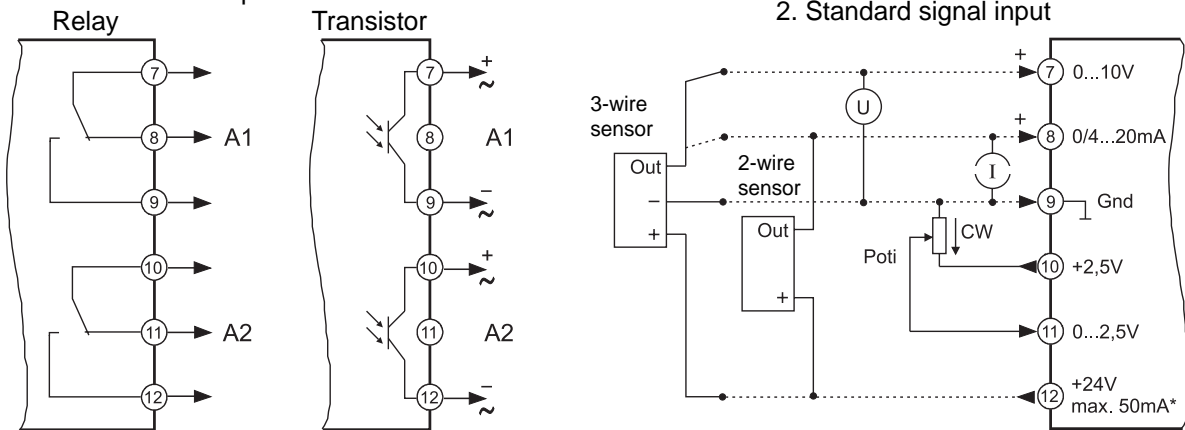

## Terminal strip C (varies with version)

2 alarm outputs

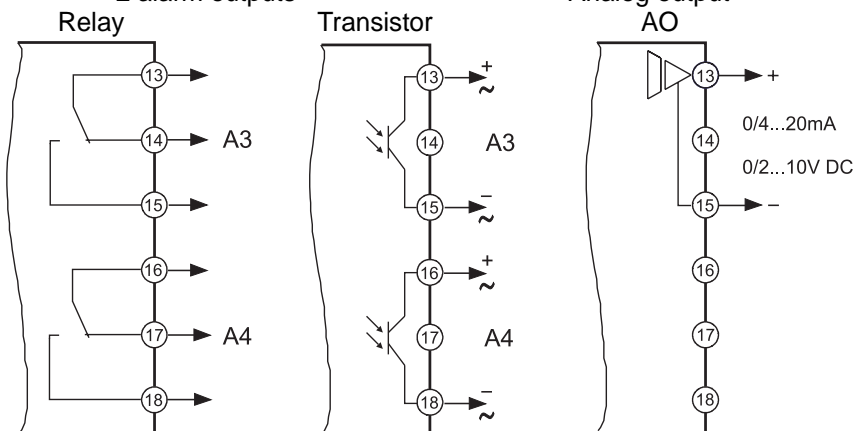

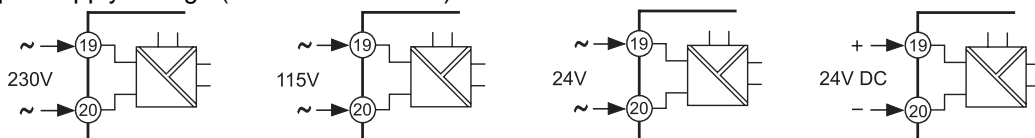

## Terminal strip D supply voltage (varies with version)

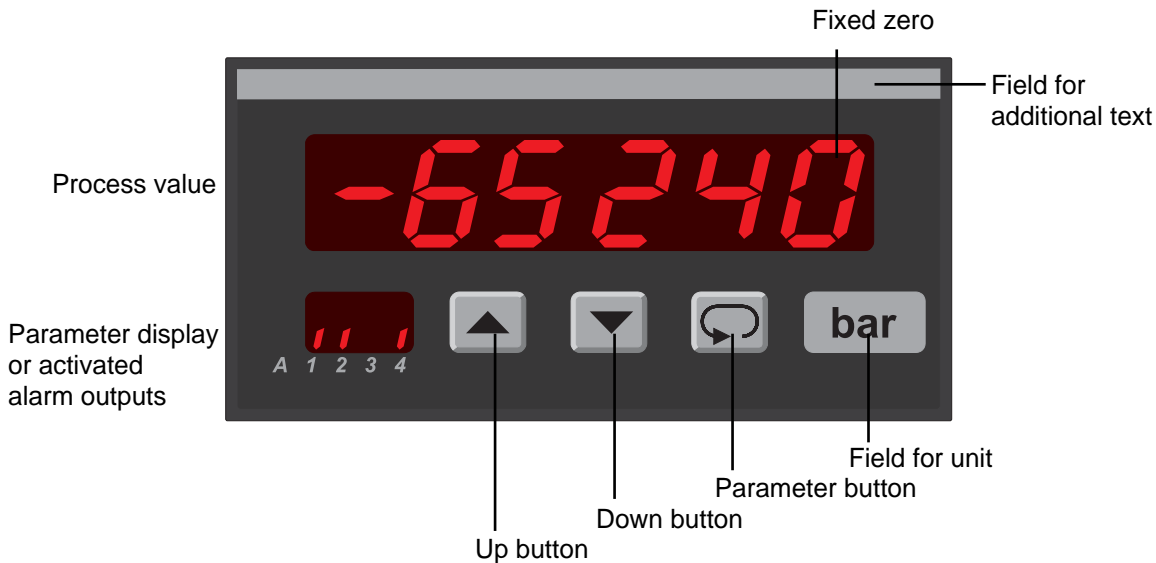

## Controls and indicators



### Description

Operation of the device is arranged in 2 levels. While programming, pressing the button  saves the current parameter and moves to the next programming step. For selection within a parameter or for entering data, use buttons  and .

After powering up, the device is located in the **Working level**. Set points of the alarm outputs can be preselected if available.

Pressing the button  for more than 2 seconds, activates the **Configuration level**. Now all the parameters which defines the function of the panelmeter can be programmed.

After finishing the configuration or when no button was pushed for more than 2 minutes, the program returns to the working level. Leaving the configuration level is possible at any time by pressing the button  for more than 2 seconds.

Parameter display as status indicator for the alarm outputs A1-A4.

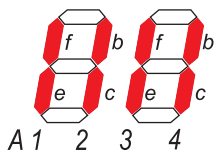

Segments f (A1 / A3) and/or b (A2 / A4) are flashing with 2 Hz, when delay time is active.

Segments e (A1 / A3) or c (A2 / A4) are output indicators.

### Error codes:

Display flashes      Overflow of the display range

*Error 1*      EEPROM test. Reading this message, a program error has been occurred. When pushing the button  a copy of the EEPROM will be reloaded and the device will work with the factory settings. If this copy does not work, please ship the panelmeter to factory for repair service.

*Loc*      Programming lock active ( see configuration page 7)

### Start-up note:

Before setting into operation, the device must be configured for the intended use.

=> see page 6

## Notes to representation



Parameter is only displayed when configured



Parameter is only displayed when feature is included (see order code)

**Please Note:** All parameters can be called if they are not blocked by other programmed parameters and if they are available. **Factory settings** are shown in the display.

## Working level

Button

Display

Description

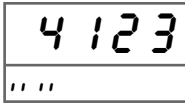

Actual value.

Alarm output indication  
(only if installed and activated).

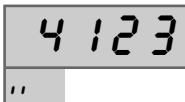

Display brightness (permanent changing possible )  
Setting possible in 9 steps with buttons ▲ and ▼ .

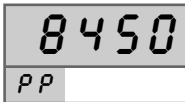

Display maximum reading.  
Reset with buttons ▲ or ▼ , or at every power off.

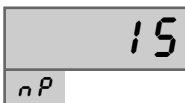

Display minimum reading.  
Reset with buttons ▲ or ▼ , or at every power off.

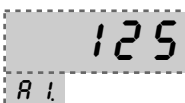









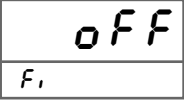



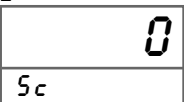



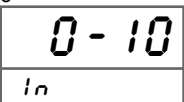



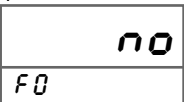



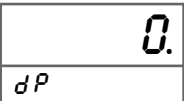











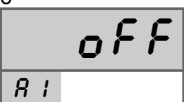

Setpoint output A1.  
Setting possible from 5 ℓ ... E n with buttons ▲ and ▼ .  
5 ℓ (start value) ... E n (end value)





**Note:** Settings of alarm outputs A1 to A4 are identical.

## Configuration

Button	Display	Description (Display graphic shows factory settings)
 Press 2 s	1  <i>OFF</i> <i>F<sub>1</sub></i>	Digitalfilter <i>oFF</i> , <i>oN</i> Averaging of the last 16 measured values continuously. Selection with buttons  and  .
 	2  <i>0</i> <i>S<sub>c</sub></i>	Indicating correction. Setting possible from -99 ... 99 digit with buttons  and  .
 	3  <i>0-10</i> <i>I<sub>n</sub></i>	Selection of the input signal. <i>0-10</i> ; <i>0-20</i> ; <i>4-20</i> ; <i>Pot</i> , Selection with buttons  and  .
 	4  <i>no</i> <i>F<sub>0</sub></i>	Fixed Zero 0, z.B 3690 + 0 <i>no</i> ; <i>YES</i> Selection with buttons  and  .
 	5  <i>0.</i> <i>dP</i>	Decimal point position <i>F<sub>0</sub> = no</i> <i>0.</i> <i>.0</i> <i>.00</i> <i>.000</i> <i>F<sub>0</sub> = YES</i> <i>0.</i> <i>.00</i> <i>.000</i> <i>.0000</i> Selection with buttons  and  .
 	6  <i>0</i> <i>S<sub>t</sub></i>	Start value for indicating range and analog output. Setting possible from -9999 ... 9999 digit with buttons  and  . In case of modification new configuration of the alarm outputs is necessary.
 	7  <i>1000</i> <i>E<sub>n</sub></i>	End value for indicating range and analog output. Setting possible from -9999 ... 9999 digit with buttons  and  . In case of modification new configuration of the alarm outputs is necessary. If $S_t > E_n$ , output works with a decreasing characteristic.
 	8  <i>OFF</i> <i>R<sub>1</sub></i>	Switching performance output A1. Function <i>oFF</i> ; <i>oN</i> (min); or <i>oN</i> (max). If activated the start value will be loaded for set point Selection with buttons  and  .
 	9  <i>0</i> <i>R<sub>1</sub></i>	Set point output A1. Setting possible from $S_t$ (start value) ... $E_n$ (end value) with buttons  and  .

continue  
page 7

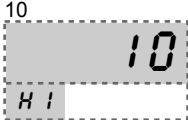
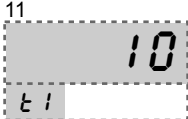
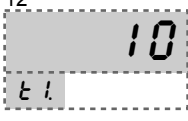
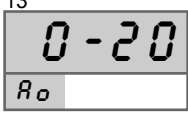
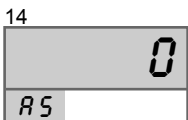
**Button      Display      Description (Display graphic shows factory settings)**

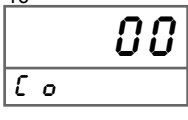
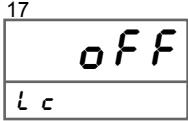
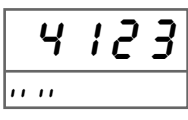
↓		<p>Hysteresis A1 Setting possible from 1 ... 9999 digit with buttons ▲ and ▼ .</p>
↻		
↓		<p>Switch-on delay time output A1. Setting possible from 0.00.00 ... 9.00.00 (h.mm.ss) with buttons ▲ and ▼ .</p>
↻		
↓		<p>Switch-off delay time output A1. Setting possible from 0.00.00 ... 9.00.00 (h.mm.ss) with buttons ▲ and ▼ .</p>
↻		<p>Note: Switching performance and set points for alarm output A2 ... A4 has to be configured in the same way.</p>
↓		<p>Analog output. 0 - 20 mA (0 - 10 V DC) or 4 - 20 mA (2 - 10 V DC). Changing from current to voltage output is load-dependent (≤ 500 Ω = current output, &gt; 500 Ω = voltage output). Selection with buttons ▲ and ▼ .</p>
↻		
↓		<p>Analog output start value (Option 08) Setting possible from 5 t ... E n of the display range with buttons ▲ and ▼ .</p>
↻		
↓		<p>Analog output end value (Option 08) Setting possible from 5 t ... E n of the display range with buttons ▲ and ▼ .</p>
↻		<p>Note: If the display range would be changed afterwards, the range of the analog output get the same values. Start- and end value of the analog output can be set anywhere in the display range. If RE &lt; R5 the output works with a decreasing characteristic.</p>
↓		<p>Code for factory settings.</p>
↻		
↓		<p>Programming lock. oFF = no lock Lo n F. = configuration level locked R L L = all parameters locked Selection with buttons ▲ and ▼ .</p>
↻		
		<p>Return to the working level</p>

## Ordering code

S9648 -  1. -  2. -  3. -  4. -  5. -  6. -  7.

### 1. Terminal strip A

1 Input standard signals  
 0/4 ... 20mA, 0 ... 10V DC and potentiometer  
 integrated transmitter-supply 24V DC max. 50mA\*

### 2. Terminal strip B

00 not installed  
 2R 2 alarm outputs Relay  
 2T 2 alarm outputs Transistor  
 S1\*\* 2nd input standard signals  
 0/4 ... 20 mA, 0 ... 10 V DC and potentiometer  
 integrated transmitter-supply 24 V DC max. 50 mA\*

### 3. Terminal strip C

00 not installed  
 2R 2 alarm outputs Relay  
 2T 2 alarm outputs Transistor  
 AO analog output 0/4 ... 20 mA or 0/2 ... 10 V DC  
 isolated

### 4. Terminal strip D supply voltage

0 230 V AC ± 10 % 50-60 Hz  
 1 115 V AC ± 10 % 50-60 Hz  
 4 24 V AC ± 10 % 50-60 Hz  
 5 24 V DC ± 15 %

### 5. Options

00 without option  
 01 Min- und Max-value hold  
 02 Difference-, average value, larger value, smaller value  
 07 Display brightness programmable  
 08 Analog output separately programmable in the display range  
 14 Input for ext. hold signal  
 19 Measuring interval 32ms (not available with all versions, please request)

### 6. Unit (appears in the unit field)

7. dditional text (appears in the field for additional text  
 max. 3 x 90 mm, WxH)

### Attention:

\* Terminal strip A+B together:  
 max. 50 mA

\*\* no isolation to terminal strip A,  
 only in connection with option 2