

Users guide

PB9648



Profibus Panelmeter 6-digit

Martens Elektronik GmbH
Kiebitzhörn 18
D-22885 Barsbüttel
Tel. +49(40)-670 73-0 • Fax +49(40)-670 73-288

Contents

1.	Brief description.....	3
2.	Safety instructions	3
2.1.	Proper use.....	3
2.2.	Control of the device.....	3
2.3.	Installation	3
2.4.	Notes on installation	3
3.	Assembly.....	4
3.1.	Installation in the panel cut-out.....	4
3.2.	Dismantling.....	5
4.	Electrical connection.....	6
4.1.	Connection terminals profibus.....	6
4.1.1.	Profibus	6
4.1.2.	Power supply.....	7
5.	Operating.....	8
5.1.	Operation and display elements	8
5.2.	Levering out the front panel and inserting again.....	8
5.3.	Inserting a dimension window	9
6.	Programming.....	10
6.1.	Programming procedure.....	10
6.2.	Parametrisation of the profibus interface.....	12
7.	Operating modes	13
7.1.	Operating mode 1.....	13
7.1.1.	Configuration data	13
7.1.2.	Output data.....	13
7.2.	Operating mode 2.....	13
7.2.1.	Configuration data	13
7.2.2.	Output data.....	13
7.3.	Operating mode 3.....	13
7.3.1.	Configuration data	13
7.3.2.	Output data.....	13
7.4.	Operating mode 4.....	14
7.4.1.	Configuration data	14
7.4.2.	Output data.....	14
7.5.	Operating mode 5.....	14
7.5.1.	Configuration data	14
7.5.2.	Output data.....	14
7.6.	Explanation about the panel parameter.....	15
7.7.	Explanation of the decimal place	15
7.8.	Explanation of the mode.....	15
7.8.1.	Modus 0.....	16
7.8.2.	Mode 1	16
8.	Error reports	17
8.1.	Overflow	17
8.2.	Error report	17
9.	Program table.....	18
10.	Technical data	19
10.1	Order code	20

1. Brief description

The **PB** is triggered via a profibus. It shows figures/or characters a 6 digit, 7-segment display.

Communication can be controlled via a busmaster. The display automatically recognises the baud rate, and the only information it needs is which profibus adresss it should use.

The latter can be parametrised via the display keyboard.

2. Safety instructions

Please read the users guide before installation and keep it for future reference.

2.1. Proper use

The **PB** is intended for displaying figures and characters.



Danger! Careless use or improper operation can result in personal injury and/or damage the equipment.

2.2. Control of the device

The panel meters are checked before dispatch and sent out in perfect condition. Should there be any visible damage, we recommend close examination of the packaging. Please inform the supplier immediately of any damage.

2.3. Installation

The **PB** must be installed by a suitable qualified specialist (e.g. with a qualification in industrial electronics).

2.4. Notes on installation

- There must be no magnetic or electric field in the vicinity of the device, e.g. due to transformers, mobile phones or electrostatic discharge.¹
- The fuse rating of the supply voltage should not exceed a value of 6A N.B. fuse.
- Do not install inductive consumers (relays, solenoid valves, etc.) near the device and suppress any interference with the aid of RC spark extinguishing combinations or free wheeling diodes.
- Keep input, output and supply lines separate from one another and do not lay them parallel with each other. Position go and return lines next to one another. Where possible use twisted pair.
- The device is not suitable for installation in areas where there is a risk of explosion.
- Any electrical connection deviating from the connection diagram can endanger human life and/or can destroy the equipment.
- The device must not be mounted in the field of direct solar radiation.
- Do not install several devices immediatly above one another. (See ambient temperature in the technical data)¹

¹ see technical data

3. Assembly

On front of the **PB** are the operating and display elements.

On the sides are the fixing elements to mount the device in the panel.

On the back are the terminals for all the electrical connections.

A sealing strip is inserted between the contact surface of the front collar and the control panel.

The **PB** is intended for installation in a control panel. Before assembly, a cut-out must be made to accommodate the device. The sizes and tolerances are given in the technical data.

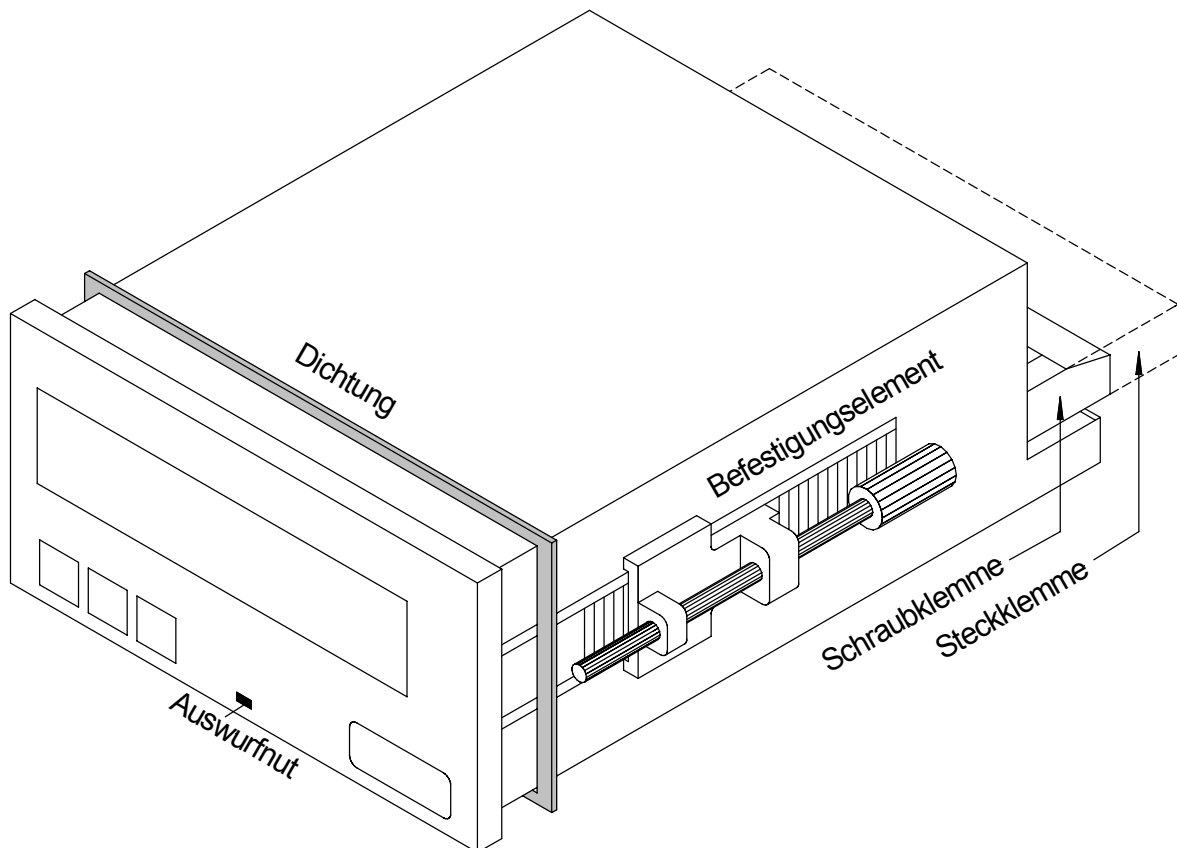

View of PB (model 96 x 48)

3.1. Installation in the panel cut-out

- I. Before inserting the unit, the side fixing elements must be pulled from the rail. To do this, slightly raise the screw head of the fixing element and pull the fixing element backwards at the same time.
- II. Lay the sealing strip around the unit and push it up against the front collar. Then push the unit from the front through the cut-out.
- III. Then place the fixing elements into the guide rails from the rear. While doing this, hold the unit from the front securely in the cut-out. Then, using a slotted screw driver, push the fixing elements as far as possible towards the front panel from the rear. Check that the sealing strip is properly positioned between the front collar and the control panel and correct it if necessary.

Assembly

- IV. Finally secure the device by tightening the screws on the fixing elements until they turn freely. The fixing elements have a slip coupling to prevent any overtightening of the thread; they hold the unit tight with the optimum amount of force.

3.2. Dismantling

To remove the unit, follow the same steps as described for assembly in reverse order.

For the version featuring the protective system IP65, a new sealing strip must be used when the unit is replaced.

4. Electrical connection

The electrical connection is made on the back of the unit.

The electrical connection will depend on the type of unit. All the connections for the **PB** are listed below. To determine which is the correct position for the connecting terminal, you should compare the interface indicated on the unit with the following table and select the right terminal position for your unit.

4.1. Connection terminals profibus

The following table lists terminal positions for the models

Terminal	Function	
1	Profibus	Data –
2		Data +
3		Data –
4		Data +
5		Term -
6		Term +
7	NC*	GND
8	NC*	
9	Screen	
10	NC*	
11	NC*	
12	NC*	
13	NC*	
14	Power supply	L+ (24V/DC)
15		L (115 V/AC)
		L (230 V/AC)
		L– (24V/DC)
		N (115V/AC)
		N (230V/AC)

The following sections describe the terminal position based on various examples

4.1.1. Profibus

In the Profibus, the units are arranged one after the other. A star-shaped configuration is not possible! A termination is needed at both ends of the data line. Any termination existing in the control system must be activated. The maximum permissible length of the data line is 1,000 m.

To simplify the connection, the terminals are duplicated. On the last unit of the bus line, the possibility exists of switching the termination to the bus line with two bridges.

Electrical connection

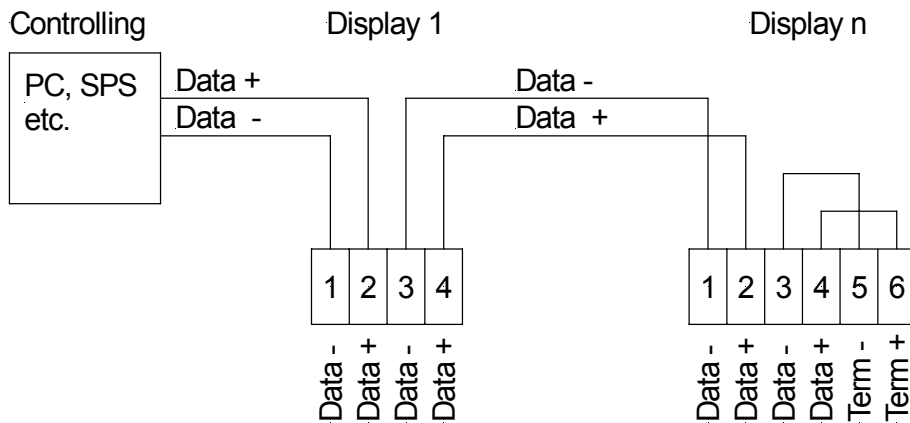

Connection of several displays to one profibus – bus line for PB devices

4.1.2. Power supply

Depending on the size of the housing, the auxiliary voltage and power supply are connected to different terminals. The 72 mm wide units are connected to terminals 10 and 11, while the units with a width of 96 mm are connected to terminals 14 and 15. It should be pointed out that the 72 mm units are intended only for operation with DC voltage.

Attention!

If the terminal plug will be removed, the Profibus is disconnected. The according terminals must be linked in the terminal plug!

5. Operating

The units are configured with two or three keys. Depending on the size of the housing, the unit has a 4 or 6-digit 7-segment display.

5.1. Operation and display elements

Housing size 96x48

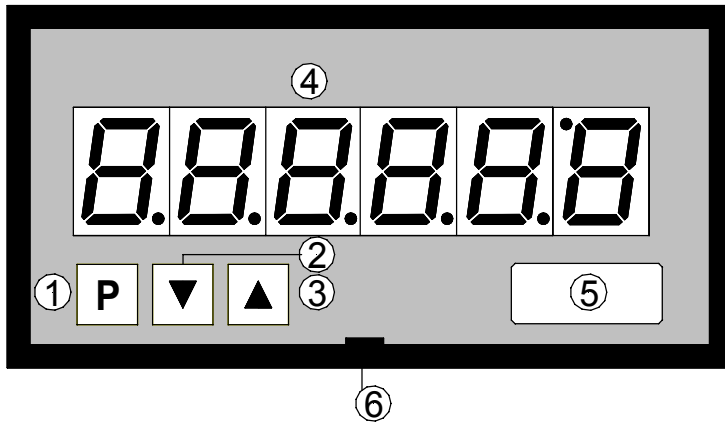

Operating and display elements

- | | | |
|---|-----------------------|--|
| 1 | Program key
[P] | With the program key, you can call up the programming mode or perform various functions in the programming mode. |
| 2 | Minus key
[DOWN] | The minus key is used in programming mode for setting parameters and in operating mode for calling up and erasing error messages. |
| 3 | Plus key
[UP] | The plus key is used in programming mode for setting parameters and in operating mode for calling up and erasing error messages. |
| 4 | Seven segment display | The seven-segment display shows digits/characters as they received, or, during the programming operation, program numbers or parameters. |
| 5 | Dimension window | Here, a physical unit can be inserted.
A dimension window can be inserted ex works, but subsequent installation by the user is also possible. |
| 6 | Ejector groove | Point for inserting a screw driver |

5.2. Levering out the front panel and inserting again

It may be necessary to remove the front of the unit for a short time to make adjustments or insert a dimension window.

- I. To remove the front, use a slotted screwdriver of size 00 or 0.

- II. Insert the screwdriver in the recessed groove as indicated and lever the front out of the front collar of the unit.
- III. To replace it, lay the front flat up against the front cover and press the bottom first, and then the top into the front collar until it audibly clicks into place.



Caution! With units having an IP65 protective system, the front must not be removed. Removing the front will permanently damage the seal.

5.3. Inserting a dimension window

- I. Remove the front panel from the housing as described above.
- II. On the back of the front panel is a slit near to the outer edge in which the dimension window must be inserted.

6. Programming

This section deals with the programming and parametrisation of the **PB**. It also describes the special features and effects of the individual parameters of the program numbers.

The 4-digit display is always used in these examples. The keys are shown below the display, although their position may deviate from this in the actual layout of the unit. If so, you can take the position and function of the keys from Chapter 5. Operating and display elements.

The display shows the program numbers (PN) right-aligned, as a two-digit number with a **P** at the front.

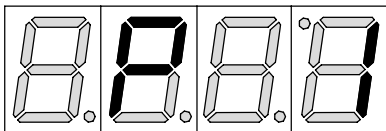

Example: Display of e.g. program number 1

6.1. Programming procedure

The entire programming of the **PB** is done by the steps described below.

Change to programming mode

Pushing the [P] key changes to programming mode. The unit goes to the lowest available program number. If the programming lock is activated, the key must be pushed for at least 1 s.

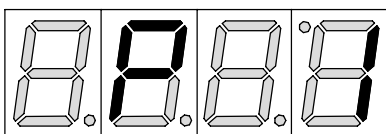

Example:

Change to programming mode by pushing key [P]. The first released program number (PN) appears, in this case PN1.

Changing to other program numbers

To change between individual program numbers, hold the [P] key down and push the for changing to a higher program number or the [▼] key for changing to a lower number. By die keeping the keys pushed, e.g. [P] & [▲], the display will begin, after approx. 1 s, to automatically run through the program numbers.

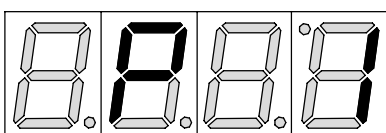

Example:

A 10 is parametrised under PN1.
Hold the [P] key down and press the [▲] several times.
After several repeats, PN1 reappears in the display.
Under this parameter, the profibus address can be changed.

Change to the parameter

Once the program number appears in the display, you can push [▼] or [▲] key to get to the parameters set for this program number. The currently stored parameters are displayed.

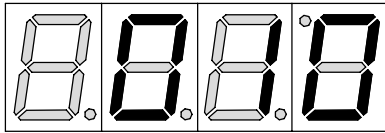

Example:

By pushing the [▼] or [▲] key, the currently stored value for PN1 appears in the display. In this case 010.

Changing a parameter

After changing to the parameter, the lowest digit of the respective parameter flashes on the display. The value can be changed with the [▲] or [▼] key. To move to the next digit, the [P] key must be briefly pushed. Once the highest digit has been set and confirmed with [P], the lowest digit will begin to flash again.

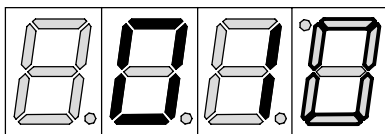

Example:

The 0 is flashing this is the lowest digit and asks if you want to change it. Let us assume the figure is to be changed from 10 to 60.

Briefly push the [P] key to move to the next digit. The 1 begins to flash. Change the figure by pushing [▲] or

[▼] to change the digit from 1 to 6. Briefly press the [P] key to move to the next digit. The 0 does not need to be changed.

Saving parameters

All parameters must be acknowledged by the user by pushing the [P] key for one second. The changed parameters are then taken over as the current operating parameters and saved in the EEPROM.

This is confirmed by horizontal bars lighting up in the display.

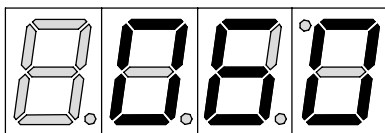

Example:

Save the parameters by pushing [P] for 1 s. All the newly entered data are confirmed by the unit. If no confirmation is received, the relevant parameters have not been saved. nicht gespeichert.

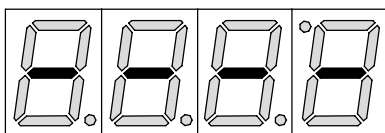

Example:

You receive confirmation from the unit that the changes have been saved through the appearance of horizontal bars in the middle segments.

Changing to the operating mode

If no key is pressed in programming mode for approx. 7 seconds, the unit automatically returns to operating mode.

6.2. Parametrisation of the profibus interface

Units with a profibus interface are parametrised via program numbers. The main program numbers are described in detail below. Further information and value ranges are given in the program number table.

Unit address PN1

The unit address can be easily programmed via PN1. The default value here is address 10, which is the factory status. After changing this parameter, the unit performs a soft reset before returning to operating mode. After this, the new address is used immediately.

Default decimal place PN3

If PN3 has been parametrised at >0, the decimal place optionally provided by the profibus is suppressed, and the decimal place requested under PN3 is incorporated.

Watchdog PN4

When PN4 >0,0 the gateway watchdog is activated.

Default brightness PN5

Via the brightness default value, the brightness can be lowered if no brightness level or 100% brightness has been set via the profibus. The value cannot be altered via the profibus.

Programming lock PN7

If this parameter is changed so that it no longer conforms to the release code PN8, then all other program numbers are saved. In operating mode, the [P] key must be pressed for at least 1 s in order to call up PN7. The default value and start value for PN7 are always "000". Since PN8 also has a default value of zero, it is possible in this way, by simply changing PN7, to lock the display against inadvertent resetting.

Release code PN8

The release code can be freely selected. This gives the code for which the programming can be released and locked under PN7. The default value has been set at "000". Should the release code become lost, the display can only be made parametrisable again by returning it to the manufacturer.

7. Operating modes

The profibus displays support 5 different operating modes as described below.

7.1. Operating mode 1

Display of 16-bit signed integers (-32768...32767).

7.1.1. Configuration data

Byte-Nr.	Identification	Description	Function
0	0x21	2 Bytes Output data	Indication value „signed integer“

7.1.2. Output data

Byte-Nr.	Function
0	Indication value High-Byte
1	Indication value Low-Byte

7.2. Operating mode 2

Display of 16-bit signed integers (-32768...32767), with brightness control, flashing and decimal place.

7.2.1. Configuration data

Byte-Nr.	Ident	Description	Function
0	0x21	2 Bytes output data	Panel parameter (see explanation 7.6)
1	0x20	1 Byte output data	decimal place (see explanation 7.7)
2	0x21	2 Bytes output data	Indication value „signed integer“

7.2.2. Output data

Byte-Nr.	Function
0 - 1	Panel parameter (see explanation 7.6)
2	Decimal place (see explanation 7.7)
3	Indication value High-Byte
4	Indication value Low-Byte

7.3. Operating mode 3

Display of 32-bit signed integer (-4.294.967.296... 4.294.967.295).

7.3.1. Configuration data

Byte-Nr.	Ident	Description	Function
0	0x23	4 Bytes Output data	Indication value „signed long integer“

7.3.2. Output data

Byte-Nr.	Function
0	Indication value High-Word, High-Byte
1	Indication value High-Word, Low-Byte
2	Indication value Low-Word, High Byte
3	Indication value Low-Word, Low-Byte

7.4. Operating mode 4

Display as 32-bit signed integer (-4.294.967.296...4.294.967.295), with brightness control flashing and decimal place.

7.4.1. Configuration data

Byte-Nr.	Ident	Description	Function
0	0x21	2 Bytes Output data	Panel parameter (see explanation 7.6)
2	0x20	1 Byte Output data	Decimal place (see explanation 7.7)
4	0x23	4 Bytes Output data	Indication value „signed long integer“

7.4.2. Output data

Byte-Nr.	Function
0 - 1	Panel parameter (see explanation) 7.6
2	Decimal point (see explanation 7.7)
3	Indication value High-Word, High-Byte
4	Indication value High-Word, Low-Byte
5	Indication value Low-Word, High-Byte
6	Indication value Low-Word, Low-Byte

7.5. Operating mode 5

Direct display control with brightness control.

7.5.1. Configuration data

Byte-Nr.	Ident	Description	Function
0	0x21	2 Bytes Output data	Panel parameter (see explanation 7.6)
2	0x20	1 Byte Output data	Mode (see explanation 7.8)
4	0x27	8 Bytes Output data	Direct indication

7.5.2. Output data

Byte-Nr.	Funktion
0 - 1	Panel parameter (see explanation 7.6)
2	Modus (see explanation 7.8)
3	1. digit (left / highest value display position)
4	2. digit
5	3. digit
6	4. digit
7	5. digit
8	6. digit
9	7. digit
10	8. Stelle (right / lowest value display position)

With 6-digit displays, the first and second places must not be selected (etc.). Nevertheless, all eight positions must always be transmitted!

Operating modes

7.6. Explanation about the panel parameter

Bit-Nr.	Function
0 - 1*	00 corresponds 100 % brightness 01 corresponds 75 % brightness 10 corresponds 50 % brightness 11 corresponds 25 % brightness
2 - 7	Reserved
8	Flashing 1. digit (left / highest display digit in 8-digit display)
9	Flashing 2. digit
10	Flashing 3. digit
11	Flashing 4. digit
12	Flashing 5. digit
13	Flashing 6. digit
14	Flashing 7. digit
15	Flashing 8. digit (right /lowest value display digit)

7.7. Explanation of the decimal place

Bit-Nr.	Function
0 - 2	000 No decimal place 001 1 Decimal place 010 2 Decimal places 011 3 Decimal places 100 4 Decimal places 101 5 Decimal places 110...6 Decimal places 111...7 Decimal places
3 - 6	Reserved
7	0 Indication 1 Display test

7.8. Explanation of the mode

Bit-Nr.	Function
0 - 6	00000000 Display via ASCII-Tabelle (see 7.8.1) 00000001 Direct controlling of the segments (see 7.8.2) 00000010 Reserved ... 01111111 Reserved
7	0 Indication 1 Display test

Operating modes

7.8.1. Modus 0

ASCII-table:

HEX	00	01	02	03	04	05	06	07	08	09	0A	0B	0C	0D	0E	0F
00																
10																
20								▣	▣	▣			▣	▣	▣	▣
30	▣	▣	▣	▣	▣	▣	▣	▣	▣	▣				▣		▣
40		▣	▣	▣	▣	▣	▣	▣	▣	▣	▣	▣	▣			▣
50	▣	▣	▣	▣	▣	▣			▣	▣	▣	▣	▣	▣	▣	▣
60	▣	▣	▣	▣	▣			▣	▣	▣	▣	▣	▣		▣	▣
70	▣	▣	▣	▣	▣	▣			▣	▣	▣	▣	▣	▣	▣	▣

All empty boxes are displayed as blanks.

7.8.2. Mode 1

Direct selection of the segments (bit-coded, all values in hexadecimal form)

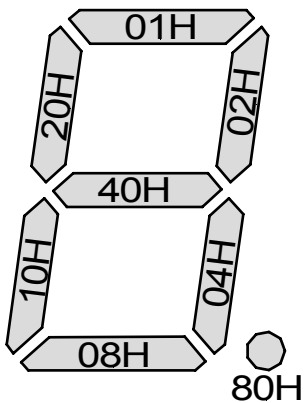

Example:

To depict the character with ASCII code 32H ("2") in mode 1, the value 5BH = (01H + 02H + 40H + 10H + 08H) must be entered in the data field.

8. Error reports

The display keeps a watch out for various error possibilities and displays the relevant error message when required.

8.1. Overflow

If a process value (integer) is bigger than the display area, a fast flashing display will appear with the defective value, i.e. with the available significant digits. The minus sign needs a place of its own.

The same happens in mode 5 when segments are selected that do not exist on the display. In this case, the defined display segments flash at high speed.

8.2. Error report

During the start-up process, the configuration is checked. This can result in an error/warning number being read from the gateway. This then reports a check total error, an EEPROM error or a profibus error.

The unit's processor then begins with the cyclical inquiry of the display segments to be shown that represent the operating mode.

Source of errors	Message	Description
Checksum error	„HLP“	Parameters in the processor not consistent
Gateway error	„Er1“	Gateway does not respond
EEPROM error	„Er2“	Communication error with EEPROM
SPC3 error	„Er3“	Gateway profibus error
PCHECKSUM error	„Er4“	Gateway check sum of a parameter is incorrect
DATA overflow	„Er5“	Gateway receives too many data
Data exchange error	„Er6“	Profibus master offline
Configuration error	„Er7“	Gateway is working in invalid mode
Watchdog overflow	„Er8“	Watchdog in the gateway has run out

In the case of an initialisation error, the error message appears directly in the display. If there is an operating error, the display responds by flashing the current data quickly for at least 10 s.

Any errors that have occurred can be called up by briefly pressing the [▲] or [▼] key and inquiries can be made about the individual errors by briefly pressing these keys several times. Each individual error can be erased by pressing the [▲] or [▼] key for about one second.

If no error has occurred, "noE" will appear. After the error report, the display automatically changes back to operating mode after about 7 s.

9. Programm table

The program number table lists all the program numbers (PN) with function, range of values and default values.

PN	Function	Range of values	Default	Res
1	Adress	1...126	10	J
3	Default decimal place when PN3 > 0	0...n Decimal place	0	N
4	Watchdog in seconds with one decimal place, whereby the watchdog is deactivated at 0.0s.	0,0...65,5	0,0	J
5	Default brightness level when PN5 > 0	0 = 100% 1 = 75% 2 = 50% 3 = 25%	0	N
7	Progammig lock	000...999	000	N
8	Autorisation code	000...999	000	N

n = number of digits – 1 ; position = memory position in the configuration memory; [Res]et after return from programming mode Y/N = Yes/No

10. Technical data

Housing

Dimensions	96 x 48 x 134 mm (BxHxT) standard 96 x 48 x 148 mm (BxHxT) including plug-in terminal 92,0 ^{+0,8} x 45,0 ^{+0,6} mm assembly cut out
Weight (96 x 48)	appr. 0,40 kg
Wall thickness	0...50 mm
Fixing	Snap in screw element
Material	PC/ABS-Blend, black, UL94V-0
Protective system	Standard IP54, 72x24; IP40 (front), IP00 (back)
Connection	Screw/plug-in terminal; line cross section up to 2,5 mm ²

Display

Digit high	14 mm
Segment colour	red
Number of digits	6-digits

Interface Profibus

Protocol	Profibus DP
Baud rate	Auto baud recognition up to 12 MBaud
Interface	RS485
Cable length	max. 1000 m
Bus termination	Pullup/-down to EN50170
Termination	Can be activated via connecting

Power supply

Supply voltage (galv. insulated)	230 V/AC / 50/60 Hz / ± 10 % 115 V/AC / 50/60 Hz / ± 10 % 24 V/DC / ± 10 %
Power consumption	max. 5 VA

Memory

Data life	Parameter memory EEPROM >30 year
-----------	-------------------------------------

Ambient conditions

Working temperature	0...60 °C
Storage temperature	-20...80 °C
Climatic resistance	rel. ≤ 75 % on year average without dew

EMV

CE-sign	DIN61326 Conformity to 89/336/EWG
---------	--------------------------------------

Safety standard

DIN 61010

10.1 Order code

PB9648 - 1. - 2. - 3. - 4.

1. Supply voltage

- 0 230V AC $\pm 10\%$
- 5 24V DC $\pm 10\%$

2. Protection

- 1 IP54 (standard)
- 2 IP54

3. Options

- 00 without
- 01 plug-in terminal (mounting depth 148mm)

4. Unit (appears on the face plate)